

FICHTNER

Consulting Engineers Limited



**Derrygreenagh
Power**



Bord na Móna

Drainage Engineering Assessment Report

Document approval

	Name	Signature	Position	Date
Prepared by:	Owen Leckie		Senior Consultant	21-11-23
Checked by:	Ahmed Taguri		Consultant	21-11-23

Document revision record

Revision no	Date	Details of revisions	Prepared by	Checked by
1	31.01.24	First Issue	OL	BNB

© 2024 Fichtner Consulting Engineers. All rights reserved.

This document and its accompanying documents contain information which is confidential and is intended only for the use of Bord na Móna. If you are not one of the intended recipients any disclosure, copying, distribution or action taken in reliance on the contents of the information is strictly prohibited.

Unless expressly agreed, any reproduction of material from this document must be requested and authorised in writing from Fichtner Consulting Engineers. Authorised reproduction of material must include all copyright and proprietary notices in the same form and manner as the original and must not be modified in any way. Acknowledgement of the source of the material must also be included in all references.

Contents

1	Introduction.....	4
1.1	Proposed Development	4
1.2	Background of report.....	4
1.3	Objective	4
1.4	Overview	4
2	Foul Water Drainage	5
2.1	Overview	5
2.2	General design detail	5
2.3	Foul water drainage design.....	5
2.4	EPA Site Characterisation Form	6
3	Surface Water Drainage	7
3.1	Overview	7
3.2	General design detail	7
3.3	Storm drainage design	8
A	Wastewater Treatment Plant.....	9
B	Storm Drainage Design.....	10
B.1	Power Plant Area	10
B.2	220 kV substation area.....	11
B.3	400 kV substation area.....	13
C	Site Characterisation Form.....	15

1 Introduction

1.1 Proposed Development

Bord na Móna Powergen Limited (Bord na Móna) is developing a new gas-fired power plant at its existing site at Derrygreenagh Bog, County Offaly, Ireland. The Proposed Development includes a combined cycle gas turbine (CCGT) plant, an open cycle gas turbine (OCGT) plant and the associated Electrical Grid Connection works.

1.2 Background of report

This report describes the design philosophy for the surface water drainage and foul water drainage for the Proposed Development.

1.3 Objective

The objectives of this document are as follows.

- Provide an overview to the surface water drainage and foul water drainage design intent for the Proposed Development.
- Provide supporting high-level calculations to evidence the drainage strategy.

1.4 Overview

The Proposed Development comprises the following areas.

- Power Plant Area.
- Electrical Grid Connection works.
 - 220 kV substation area.
 - 220 kV overhead line corridor.
 - Line-cable interface compound.
 - 220 kV underground cable corridor.
 - 400 kV substation area.

The strategy for the foul water drainage is presented in section 2.

The strategy for the surface water drainage is presented in section 3.

The foul water and surface water drainage design is also detailed in the following drawings.

- S7060-8050 0044-1
- S7060-8050 0044-2
- S7060-8050 0044-3
- S7060-8050 0044-4

2 Foul Water Drainage

2.1 Overview

The only occupied areas of the Proposed Development are the Power Plant Area and the substation areas.

Power Plant Area

The Power Plant Area will have continuous occupation. A wastewater treatment plant by Tricel (or similar) is to be installed to treat the foul water arising from the Power Plant Area.

The treated foul water effluent will be discharged from the wastewater treatment plant to the process water tank. From the process water tank, the treated water will be discharged to the Yellow River.

220 kV and 400 kV substation areas

The 220 kV and 400 kV substations will be infrequently occupied. Foul water holding tanks will be installed to service the 220 kV and 400 kV substation areas. The holding tanks are to be periodically emptied and the effluent disposed of offsite at an authorised facility.

The sizing of the holding tank will be carried out at detailed design stage.

2.2 General design detail

Drains generally will consist of PVC (to IS EN ISO 1452) or concrete socket and spigot pipes (to IS 6) and will be laid to comply with the Building Regulations 1997, in accordance with the recommendations contained in the Technical Guidance Documents, Section H and with the Greater Dublin Regional Code of Practice for Drainage Works. Foul water sewers will consist of PVC or concrete socket and spigot pipes (to IS 6) and laid strictly in accordance with Irish Water and Offaly County Council requirements.

Choice of pipe size and material will be determined at detailed design stage.

2.3 Foul water drainage design

Supplier information for the Power Plant Area wastewater treatment unit is included in Appendix A. The unit has been sized to suit a population equivalent (PE) of 60.

The foul water system proposal is as follows:

- Tricel Maxus system (or similar) containing a Mars 5000 x 2 system followed by a 9,000 litre, 150m² sand polishing filter.
- The system includes a minimum 10,800 litre primary settlement and buffer tank which feeds the 2No. Mars 5,000 litre treatment plant.
- Post-treatment of the liquid with a sand filter before discharging to the process water tank.¹

¹ Supplier information shows a Tricel Sandcel system. An impermeable base will be installed to provide full onward discharge of liquid to the process water tank.

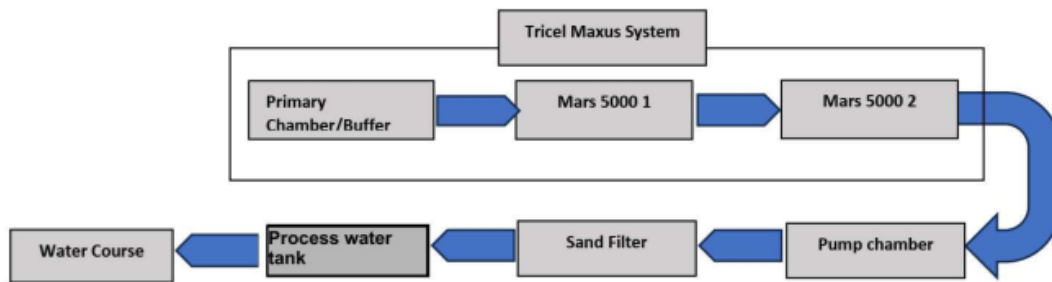

Figure 1 - Foul water process stages

2.4 EPA Site Characterisation Form

The EPA Site Characterisation Form has been included in Appendix C.

Brenden Slevin & Associates has completed sections 1 to 3 to detail the results of its site testing. Fichtner Consulting Engineering Ltd. has completed sections 4 to 6 following engagement with Tricel.

3 Surface Water Drainage

3.1 Overview

Power Plant Area

Runoff from buildings and hardstanding will be collected via the surface water drainage system, through an attenuation system and discharged to the River Mongagh. The surface water will be passed through a silt trap and class 1 hydrocarbon interceptor prior to entering the attenuation system.

220 kV and 400 kV substation areas

All surface water from buildings and hardstanding shall be fed through a silt trap and hydrocarbon interceptor and collected in an attenuation system. From the attenuation system, the surface water will be discharged to existing local drainage channels at greenfield runoff rates.

The permanent access roads are to have a concrete surface. Surface water shall be caught in drainage channels either side of the road. Drainage channels are then connected into the surrounding local drainage channels.

220 kV overhead line corridor and underground cable corridor

Any exposed concrete plinths at the 220 kV overhead line pylon bases will be laid to fall. Surface water will drain to surrounding ground.

Floating roads are proposed over areas of peat. Any surface water will fall to the sides of the road into the surrounding ground.

Where the existing landscape within the development boundary remains unchanged, no additional drainage is proposed.

Line-cable interface compound

Crushed limestone aggregate on a geotextile membrane will be used within the compound fencing. Surface water will be free to percolate to ground through the crushed aggregate.

Any exposed concrete plinths will be laid to fall. Any surface water will drain to the surrounding ground.

3.2 General design detail

Strict separation of surface water and wastewater will be imposed on the development. Drains will be laid out to minimise the risk of inadvertent connection of sinks etc. to the surface water system.

To minimise the risk of floating contamination of the surface water system, road gullies will be precast trapped gullies to BS5911: Part 2:1982.

Surface water local drains will consist of PVC (to IS 123) or concrete socket and spigot pipes (to IS 6). These drains will be laid to comply with the Requirement of the Building Regulations 1997, and in accordance with the recommendations contained in the Technical Guidance Documents, Part H and comply with the Greater Dublin Regional Code of Practice for Drainage Works.

Surface water drainage will consist of PVC or concrete socket and spigot pipes (to IS 6) and laid strictly in accordance with Offaly County Council requirements.

Selection of pipe size and material will be determined at detailed design stage.

3.3 Storm drainage design

Refer to appendix B for outputs from the storm drainage design calculations.

A Wastewater Treatment Plant

Typical detail for the wastewater treatment plant is included overleaf.

IRELAND



WASTEWATER TREATMENT

Tricel® Maxus

Treatment Systems for 50+ Population Equivalent

Innovative design for superior performance



What is Tricel Maxus

Tricel Maxus wastewater treatment plants are designed to treat wastewater arising from human activity in applications greater than 50PE. Applications includes housing estates, hotels, restaurants, campsites, factories or retail units to name a few. These highly versatile systems are individually sized to suit every possible scenario over 50PE.

The Tricel Maxus operates on Submerged Aerated Filter (SAF) technology. The plant is controlled by the E-III control panel through which all electrical components are connected. They are robust and easy to install with multiple configurations possible to suit any site. Simple in operation, they are easy to maintain over the lifespan of the product.

How does it work

Tricel Maxus utilises highly effective SAF technology treating wastewater in 4 stages:

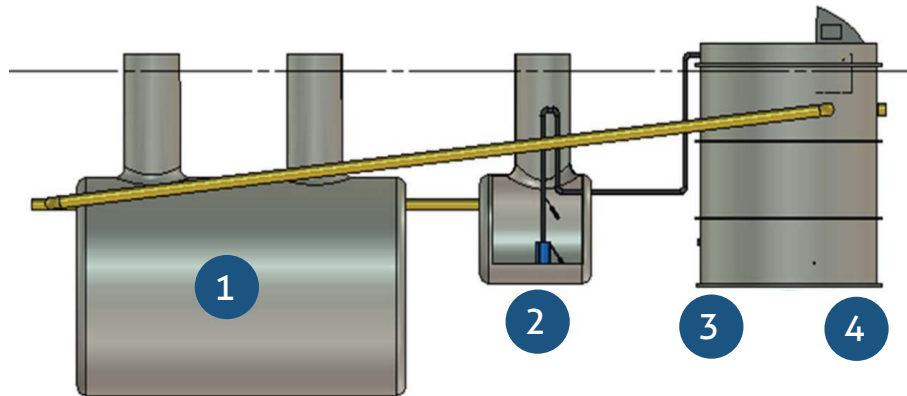

1. Wastewater enters into the Tricel Maxus system in **the settlement tank**. Here primary treatment occurs. Heavy solids are separated out of the wastewater and settle to form a sludge on the base of the tank. Lighter solids, such as oils, fats or grease, float to top of the wastewater and are retained within the settlement tank.
2. From here the partially treated wastewater enters **the buffer tank**. The buffer tank will even out any fluctuations for the incoming water load. Pumps located at the bottom of the buffer tank feed the wastewater forward into the treatment plant.
3. In **the biological treatment zone**, the submerged aerated filter, with a large surface area for the microbes, is exposed to aeration as the wastewater passes through. The control panel adjusts the aeration to match the incoming flow to ensure extremely efficient operation. The system will never clog and does not need any maintenance or chemicals.
4. In **the clarifier**, bio sludge from the treatment process settles out of the treated liquid. Airlift pumps recirculate the bio sludge from the base of the tank back to the settlement tank. The fully treated liquid is now ready to discharge from the plant.

Key features & benefits

- ▶ **Excellent treatment** from proven SAF technology.
- ▶ **Ideal for seasonal loads of constant loads.** The control panel will automatically adjust to the incoming load to ensure optimum performance.
- ▶ **Extensively tested and ETA verified for holiday home applications.** System will go into power saving mode during periods of no flow and restart once flow is detected without the need for any manual inputs.
- ▶ **Swift back up and service located in Ireland.** Range of service contracts available.
- ▶ **Full design engineered solutions offered.** Bespoke solutions offered for every unique site to ensure best performance. **GRP or Concrete settlement tank options.**
- ▶ **Flexible installation options to suit any site.** This can fit plants into difficult sites or simply save space.
- ▶ Versatile technology which **can adapt to different loadings or effluent strengths.**
- ▶ Simple operation using long life reliable components leading to **low running costs.** No moving parts within the plant making it easy to maintain.

Call us today for a Free Quote +353 (0) 64 6632421
email: sales@tricel.ie

Installations



▶ Installation with combined GRP settlement and buffer tanks.



▶ Treatment plant during installation.



▶ Remote settlement and buffer tanks to suit a site with restricted space.



▶ Installation with combined GRP settlement and buffer tanks.



▶ Treatment plant during installation.



▶ Finished installation.

Technical characteristics/ Plant dimensions

Code	PE	Settlement And Buffer Tank*				Treatment Plant			
		Tank	L (M)	W (M)	H (M)	Plant Shape**	L (M)	W (M)	H (M)
66M5000	66	Settlement	6.60	1.64	2.05	Circular	2.00	2.00	2.20
		Buffer	1.60	1.64	2.05				
88M6000	88	Settlement	6.60	1.64	2.05	Circular	2.30	2.30	2.20
		Buffer	3.60	1.64	2.05				
112J25	112	Settlement	6.60	1.64	2.05	Rectangular	2.80	2.16	2.22
		Buffer	6.60	1.64	2.05				
154J50	154	Combined	5.70	2.87	2.70	Rectangular	3.30	2.16	2.22
175J75	175	Combined	6.17	2.87	2.70	Rectangular	3.95	2.16	2.22
238J100	238	Combined	9.05	2.87	2.70	Rectangular	5.45	2.16	2.22
294J50X2	294	Combined	10.89	2.87	2.70	Rectangular	6.60	2.16	2.22
385J75X2	385	Combined	14.12	2.87	2.70	Rectangular	7.90	2.16	2.22
560J100X2	560	Settlement	9.95	2.87	2.70	Rectangular	10.90	2.16	2.22
		Buffer	9.95	2.87	2.70				

*All settlement and buffer tank dimensions are for GRP tanks as standard. Concrete options are available.

** Please note, the treatment plant is circular for up to 88PE and rectangular for plants over 88PE.

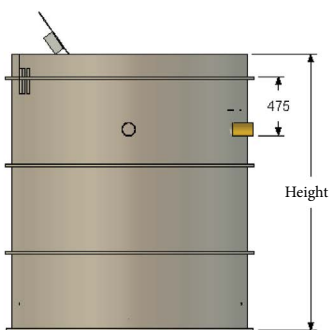

Profile view of circular shape

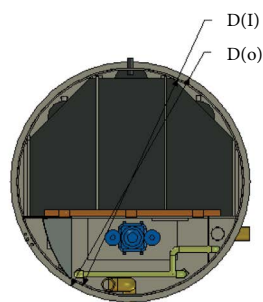

Top view of circular shape

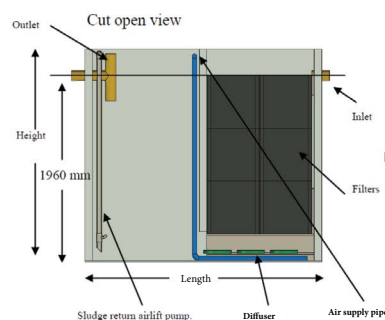

Profile view of rectangular shape

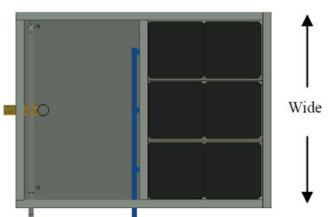

Top view of rectangular shape

Tricel Group

Tricel is a world recognised global provider of **high-performance solutions**. Today, the company operates across multiple industries such as **Environmental, Construction, Water and Distribution**, including both composite materials and lubricants.

We occupy a unique position in the field of reinforced plastics, combining the technical expertise of **over 60 years in the press-moulding and composites industry**. Tricel is proud of being one of the largest manufacturers of wastewater treatment plants in Europe, and are regarded by regulators as the standard setters within the industry.

Our company offers industry **leading innovative solutions** that our customers can trust, and with operations in 12 locations across Europe we supply a comprehensive range of products to **over 50 countries worldwide**.

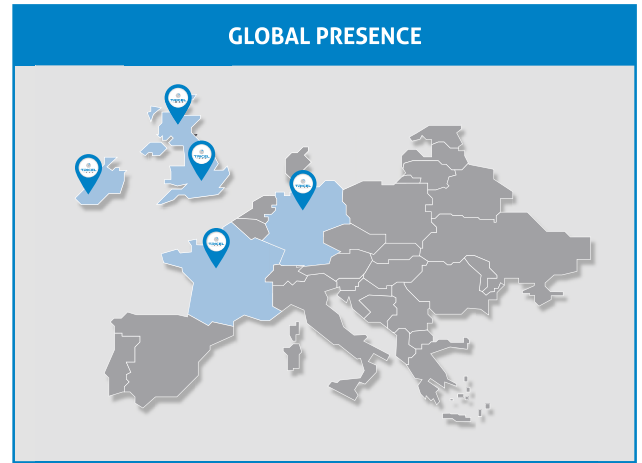

Membership of European governing bodies on wastewater treatment



The **Irish Water Treatment Association (IWTA)** is the national association for the treatment, conservation, recycling and reuse of water and wastewater.



The **Irish Onsite Wastewater Association (IOWA)** formed in 2007 with the goal of improving the standard of professionalism in the on-site treatment of wastewater in Ireland.

Our Full Range of Tricel® Wastewater Treatment Solutions



Tricel® Novo
Wastewater Treatment Plant



Tricel® Vento
Septic Tank



Tricel® Puraflo
Packaged Filter System



Tricel® Supra
Wastewater Treatment Plant

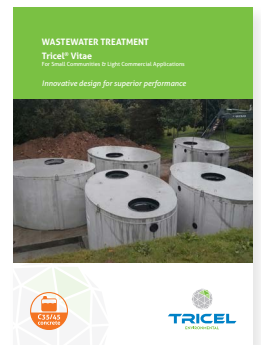

Tricel® Vitae
Wastewater Treatment Plant

Call us today for a Free Quote +353 (0) 64 6632421
email: sales@tricel.ie

Tricel, Ballyspillane Industrial Estate, Killarney, Co Kerry, Ireland
Tel: +353 (0) 64 6632421 | Email: sales@tricel.ie | www.tricel.ie

In accordance with Tricel's normal policy of product development these specifications are subject to change without notice.
Tricel (Killarney) Unlimited Company trading as Tricel



SAND POLISHING FILTER

Tricel® Sandcel

Innovative design for superior performance

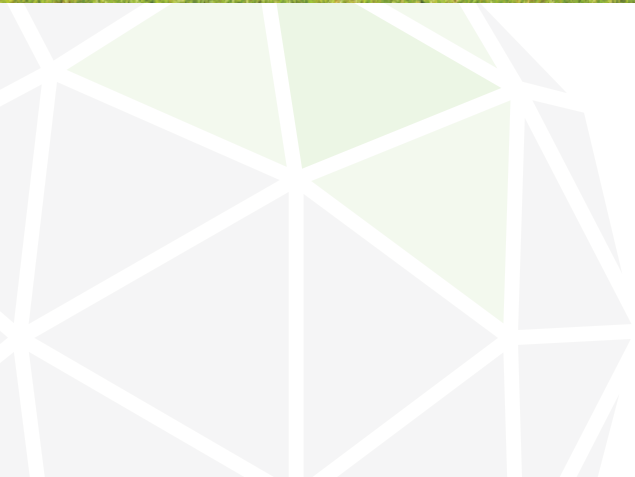

TRICEL
ENVIRONMENTAL

How a Tricel Sandcel works

Sandcel sand polishing filters are designed to the EPA Code of Practice as tertiary treatment systems. These filters are the perfect solution for treatment and disposal of effluent from a secondary treatment unit. The filters comprise of stratified layers of certified sands according to the EPA Code of Practice.

They are enclosed in GRP impermeable panels which will not rot or decay, ensuring the structure of the filter will hold for many years. The filters can be installed above or below ground with all pipe work accessible from a service pod.

Treatment efficiency:
Sandcel filters provide excellent polishing of treated effluent. Sample testing of some sites where a Sandcel and Tricel Novo wastewater treatment plant were in operation have shown final effluent quality of <1 mg/ltr BOD₅.



Why buy a Tricel Sandcel?

<p>Solid impermeable structure</p> <p>Filter enclosure will not rot or decay like timber surrounds.</p>	<p>Small footprint</p> <p>Only 16m² area for a 6 person application eliminating the need of large percolation area.</p>	<p>Aesthetic finish</p> <p>Filter can be covered with topsoil and planted with a lawn to blend into garden.</p>
<p>Long life components</p> <p>Certified sands and gravel used as the filter bed which will not break down over time.</p>	<p>Flexible design</p> <p>Under and overground applications possible.</p>	<p>Future</p> <p>Pipework accessible from service pod to future proof your system.</p>
<p>Engineered design</p> <p>Specifically designed pipework network to ensure equal distribution over the entire bed.</p>	<p>High performance</p> <p>Excellent treatment of effluent.</p>	<p>Legacy sites</p> <p>Ideal compact solution designed to the EPA CoP fulfilling most Local Authority requirements.</p>
<p>Quick installation</p> <p>Reduced on site labour costs.</p>	<p>Certification</p> <p>Certified components used.</p>	<p>Peace of mind</p> <p>Tricel have earned an unrivalled reputation in the environmental field in over 20 countries worldwide.</p>

Drawing of Sandcel

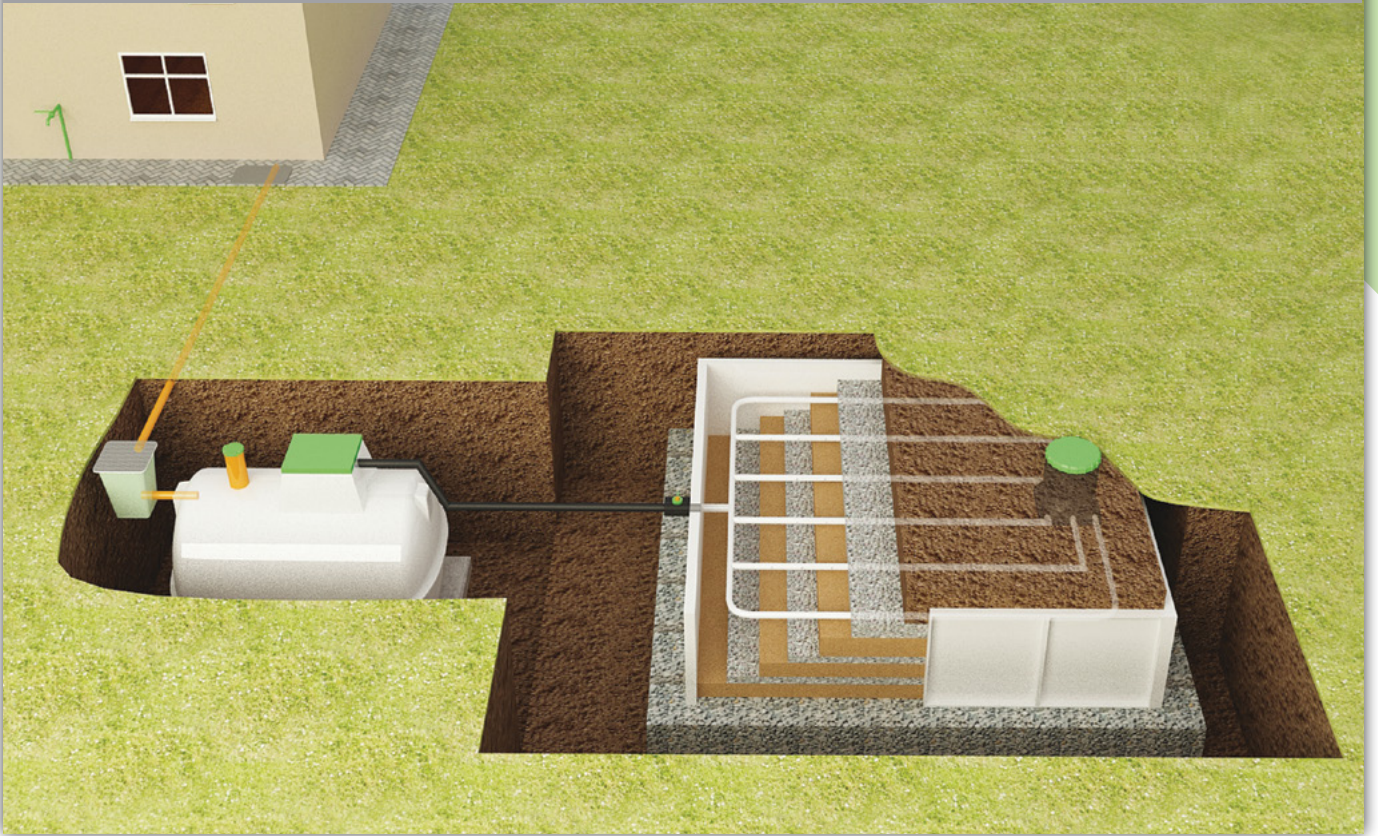

Sandcel during installation



Sandcel installed

Tricel Sandcel

-Up to 10 persons-

	Sandcel 900	Sandcel 1200	Sandcel 1500
Capacity	900 litres per day	1200 litres per day	1500 litres per day
Length	4000mm	4000mm	4000mm
Width	3850mm	5000mm	6350mm
Depth	1000mm	1000mm	1000mm
Footprint	15.4m ² (165.77 sq/ft)	20.0m ² (215.28 sq/ft)	25.4m ² (269.10 sq/ft)

>10 persons available on request.

Tricel Group

Tricel is an established and world recognised global provider of **high performance solutions** for the **Construction, Environmental, Water and Materials Industries** and is a brand built upon service, back up and reliability.

We occupy a unique position in the field of reinforced plastics, combining the technical expertise of **over 40 years in the press-moulding and composites industry**. Tricel is proud of being one of the largest manufacturers of Wastewater Treatment plants in Europe, and are regarded by regulators as the standard setters within the industry.

Tricel are **experts in Sheet Moulding Compound (SMC)** processes and produce the only wastewater treatment plant in Europe constructed from this material. This process gives the highest strength to thickness ratio of any tank on the market, and has no risk of corrosion over time.

Our company offers industry **leading innovative solutions** that our customers can trust, and with manufacturing locations in 5 countries we supply a comprehensive range of products to **over 50 countries worldwide**.

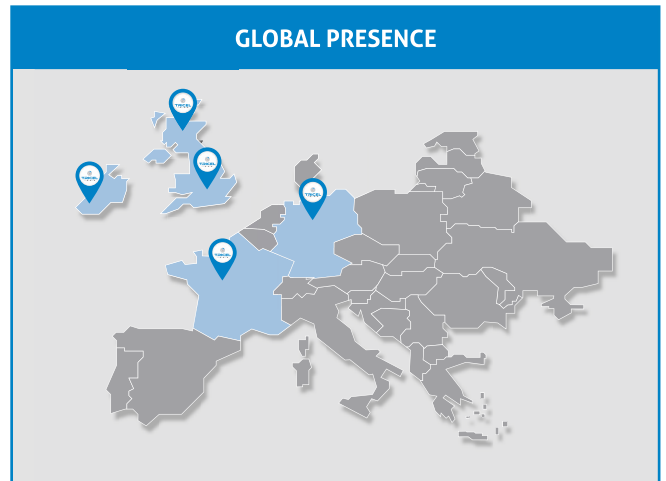

The **Irish Water Treatment Association (IWTA)** is the national association for the treatment, conservation, recycling and reuse of water and wastewater.



The **Irish Onsite Wastewater Association (IOWA)** formed in 2007 with the goal of improving the standard of professionalism in the on-site treatment of wastewater in Ireland.



Sandcel sand polishing filter has been designed in accordance to the **Environmental Protection Agency (EPA) Code of Practice (CoP)**.

Environmental solutions



Novo
Domestic wastewater treatment plants



Vento
Septic tanks



Sandcel
Sand polishing filter



Pump stations

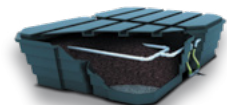

Puraflo
Secondary & Tertiary treatment plants

Get a Quote

Contact us Today to get a free quote on **00 353 (0)64 663 2421**
or email us at sales@tricel.ie

Tricel, Ballyspillane Industrial Estate, Killarney, Co. Kerry, Ireland.
Tel: +353 (0) 64 6632421 | Email: sales@tricel.ie | www.tricel.ie

In accordance with Tricel's normal policy of product development these specifications are subject to change without notice.
Tricel (Killarney) Unlimited Company trading as Tricel.



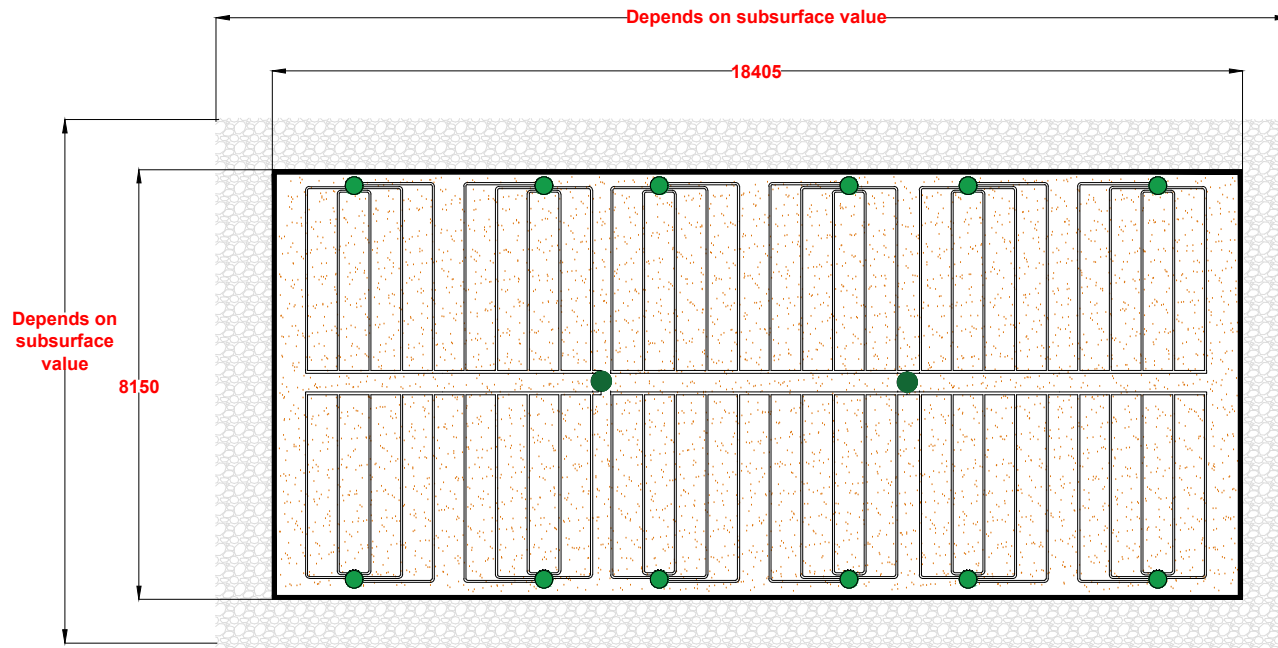

TRICEL
GENERATIONS OF INNOVATION

SALES SPECIFICATION

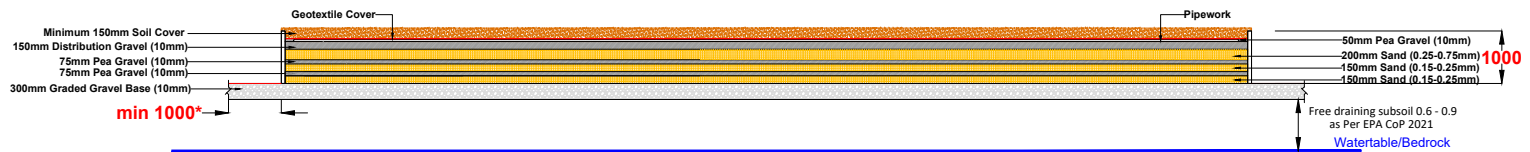

*Gravel base should be minimum 1m longer and wider than the Sandcel on all sides i.e. 10150 x 20405



	BY	DATE	PRODUCT NAME:	WEIGHT:	SCALE	PART NO:	SIZE
DRAWN:	TH	15/11/18	SANDCEL 9000L		NOT TO SCALE	SCIE09000AE	N/A
TOLERANCE:	+/-5		COUNTRY : IRELAND		REV. NO. 00.00		
MATERIAL:	GRP		UNITS: MILLIMETERS		TANK REVISION:		
TRICEL (KILLARNEY) UNLIMITED COMPANY RESERVES THE RIGHT TO CHANGE THE SPECIFICATION WITHOUT PRIOR NOTIFICATION.						ISSUE DATE: 5/12/18	
PRINTED COPIES OF THIS DOCUMENT ARE UNCONTROLLED UNLESS STATED OTHERWISE							

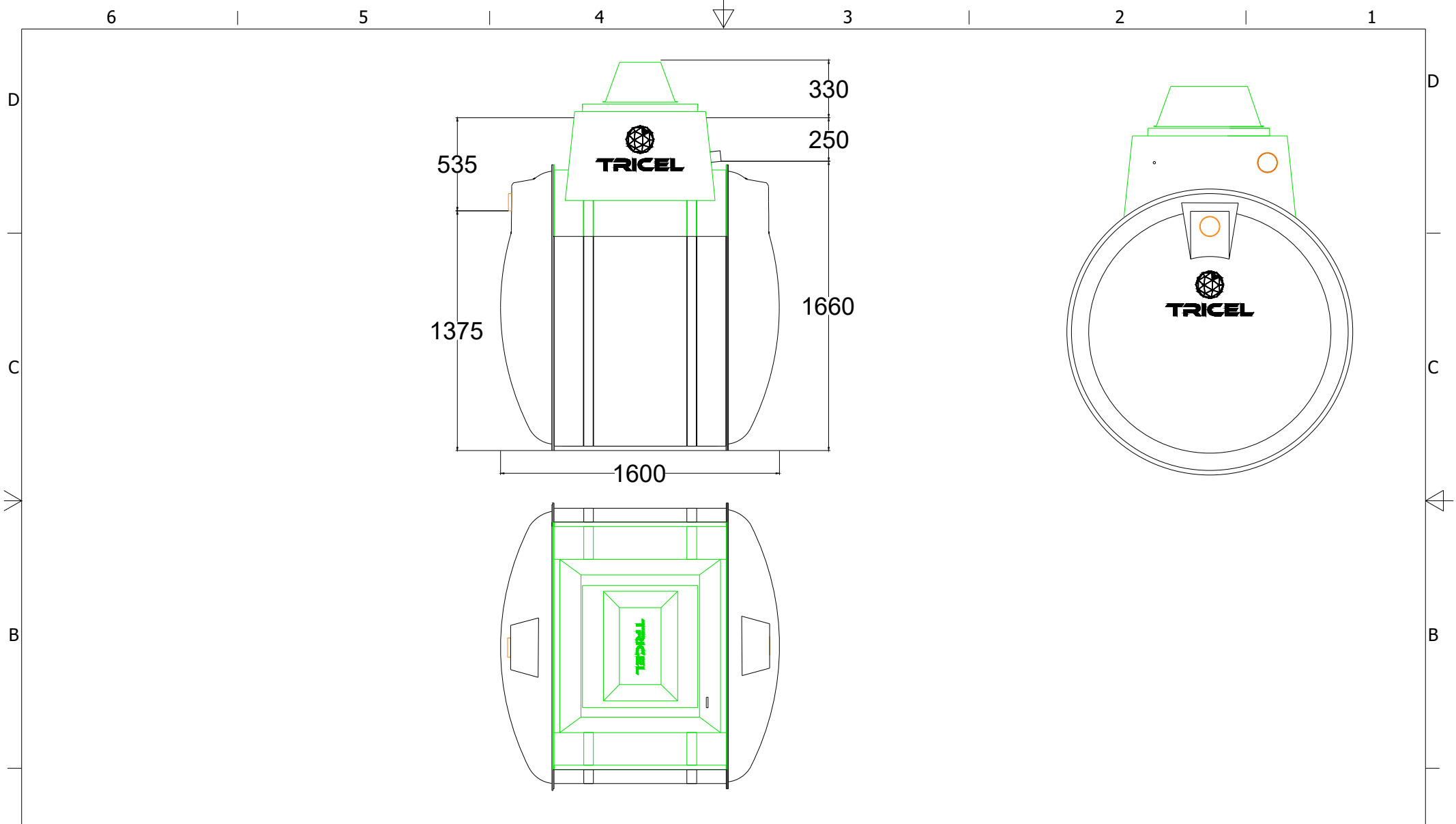

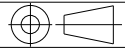
DRAWN BY		DRAWING DATE (DD/MM/YY)		EFFECTIVE DATE: (DD/MM/YY)		PRODUCT NAME:		PRODUCT NUMBER:		ACC NUMBER:		 TRICEL
NR		11/03/19		12/03/19		Pumping Chamber 2600Ltr		221811, 103057				
TOLERANCE: +/- 5				MATERIAL: SMC		SCALE: NOT TO SCALE		DRAWING TYPE: FG				
UNITS: mm				DRWG NO: N/A		TANK REVISION:		REV. NO.		PAGE SIZE: A4		
JOB NUMBER: N/A				WEIGHT (KG): 270		PROJECT NO: #321		ECO NO: 74		COUNTRY: IE & UK		

B Storm Drainage Design

Supporting storm drainage design outputs are provided below for the Power Plant Area and Electricity Grid Connection.

B.1 Power Plant Area

The Power Plant Area has a hardstanding area of c. 51,100 m².

Calculations carried out using ICP SUDS/IH 124 on Infodrainage software show the QBar Rural to be 14.1 l/s. This is greater than 2 l/s/ha and should therefore be considered as the maximum rate of surface water discharge from site.

Attenuation requirements have been identified of 4,569 m³ to 6,550 m³.

Infodrainage outputs for the Power Plant Area are shown in Figure 2 and Figure 3.

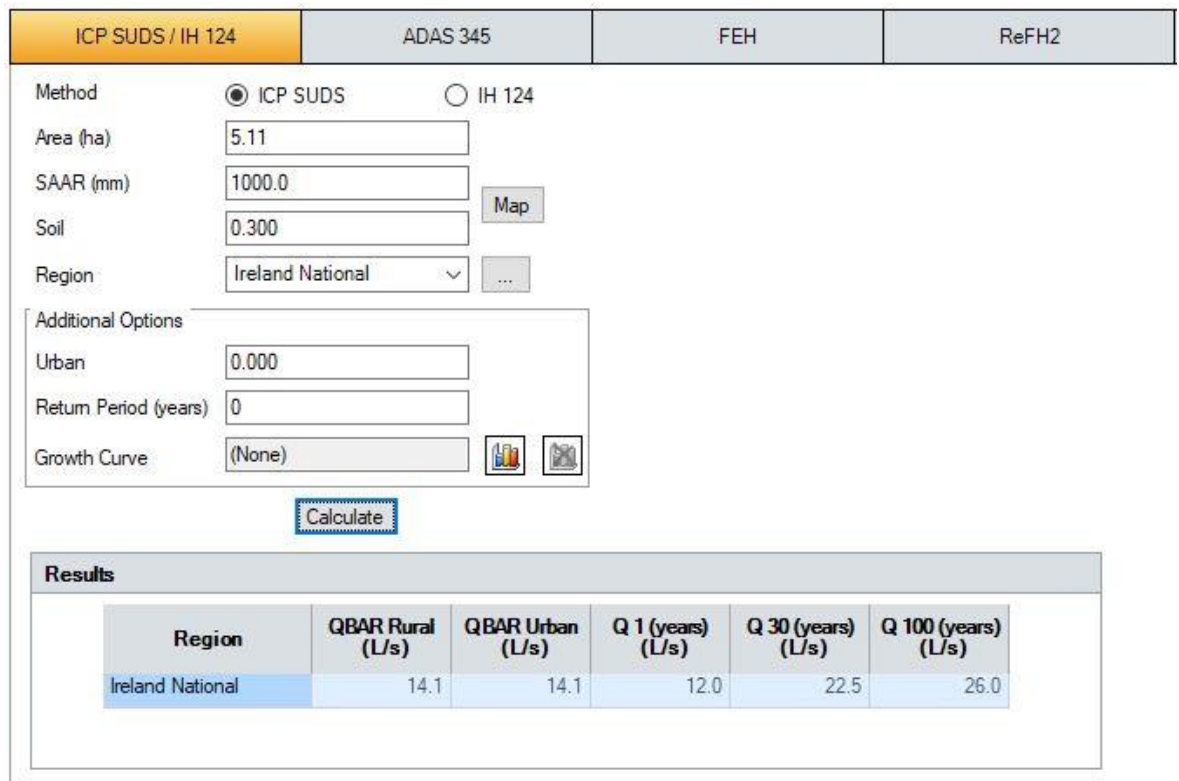

Figure 2 - Infodrainage outputs for Power Plant Area

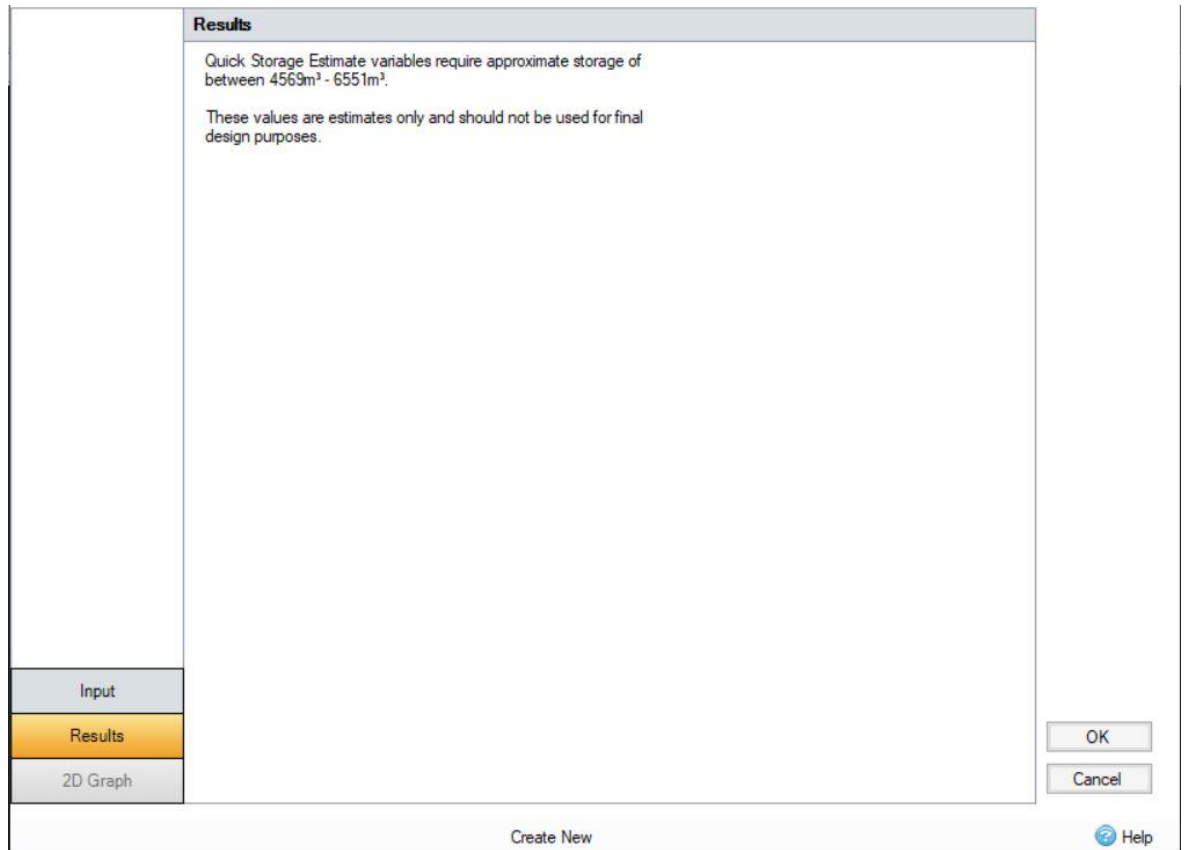

Figure 3 - Infodrainage outputs for Power Plant Area

B.2 220 kV substation area

The 220 kV substation area has a hardstanding area of c. 3,400 m².

Calculations carried out using ICP SUDS/IH 124 on Infodrainage software show the QBar Rural to be 1 l/s. This is greater than 2 l/s/ha and should therefore be considered as the maximum rate of surface water discharge from site. However, to adequately limit the rate of discharge to 1 l/s the flow control device must have an orifice diameter of approximately 28 mm. This is considered particularly small and would have potential to create a blockage risk. Greater Dublin Strategic Drainage Study (GSDSDS) recommends a minimum orifice diameter of 200 mm (Volume 2 paragraph 6.3.3.1) limiting the discharge rate to 25 l/s. It is considered that a minimum orifice diameter of 50mm is acceptable, restricting the rate of run-off to 2.0 l/s. The flow control device would be fitted with a bypass door to enable clearance of blockages, and with high level overflow pipework as recommended by GSDSDS.

Attenuation requirements have been identified at 242 m³ to 338 m³.

Infodrainage outputs for the 220 kV substation area are shown in Figure 4 and Figure 5.

ICP SUDS / IH 124	ADAS 345	FEH	ReFH2			
Method	<input checked="" type="radio"/> ICP SUDS <input type="radio"/> IH 124					
Area (ha)	0.344					
SAAR (mm)	1000.0					
Soil	0.300					
Region	Ireland National					
Additional Options						
Urban	0.000					
Return Period (years)	0					
Growth Curve	(None)					
Calculate						
Results						
	Region	QBAR Rural (L/s)	QBAR Urban (L/s)	Q 1 (years) (L/s)	Q 30 (years) (L/s)	Q 100 (years) (L/s)
	Ireland National	1.0	1.0	0.8	1.5	1.8

Figure 4 - Infodrainage outputs for 220 kV substation area

Input	Results	2D Graph
	<p>Results</p> <p>Quick Storage Estimate variables require approximate storage of between 242m³ - 338m³.</p> <p>These values are estimates only and should not be used for final design purposes.</p>	
Create New		
<input type="button" value="OK"/> <input type="button" value="Cancel"/> <input type="button" value="Help"/>		

Figure 5 - Infodrainage outputs for 220 kV substation area

B.3 400 kV substation area

The 400 kV substation area has a hardstanding area of c. 6,600 m².

Calculations carried out using ICP SUDS/IH 124 on Infodrainage software show the QBar Rural to be 1.8 l/s, this is greater than 2 l/s/ha and should there be considered as the maximum rate of surface water discharge from site. However, to adequately limit the rate of discharge to 1 l/s the flow control device must have an orifice diameter of approximately 45 mm. This is considered particularly small and would have potential to create a blockage risk. Greater Dublin Strategic Drainage Study (GSDSDS) recommends a minimum orifice diameter of 200mm (Volume 2 paragraph 6.3.3.1) but this would only limit the discharge rate to 25 l/s. It is considered that a minimum orifice diameter of 50 mm is acceptable, restricting the rate of run-off to 2.0 l/s. The flow control device would be fitted with a bypass door to enable clearance of blockages, and with high level overflow pipework as recommended by GSDSDS.

Attenuation requirements have been identified of 572 m³ to 810 m³.

Infodrainage outputs for the 400 kV substation area are shown in Figure 6 and Figure 7.

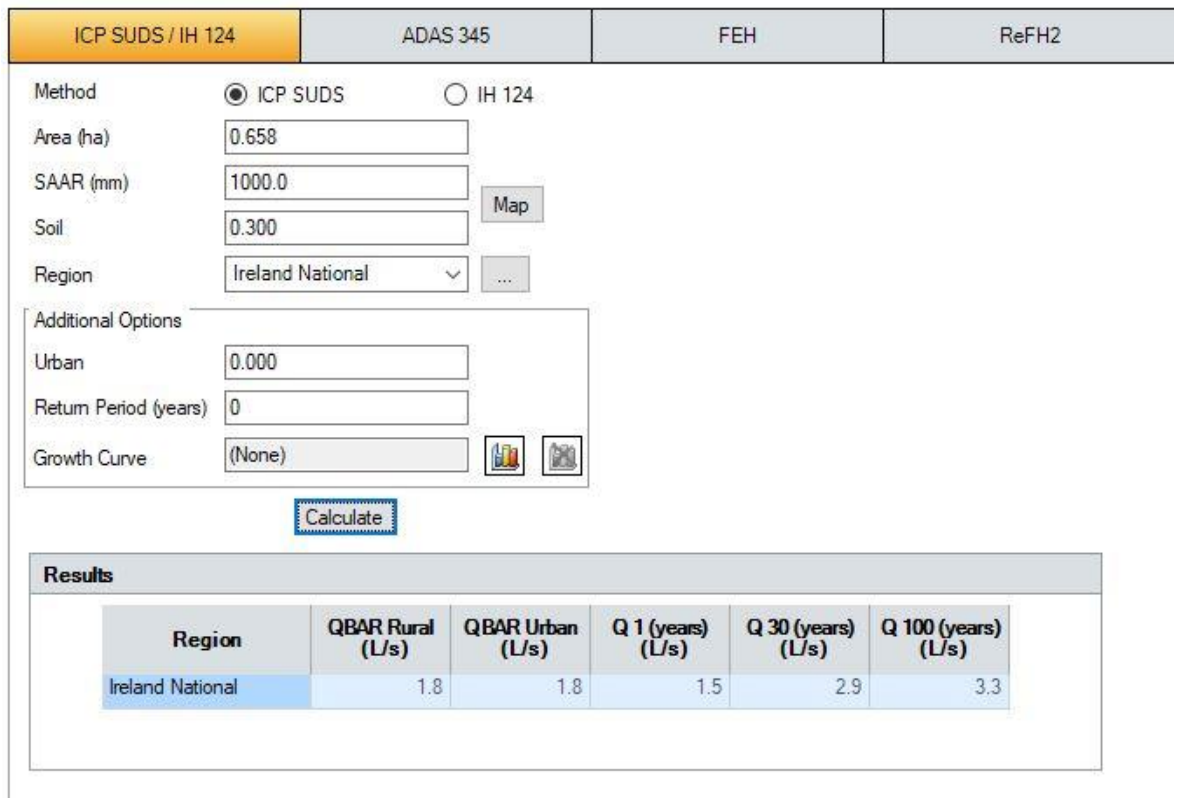

Figure 6 - Infodrainage outputs for 400kV substation area

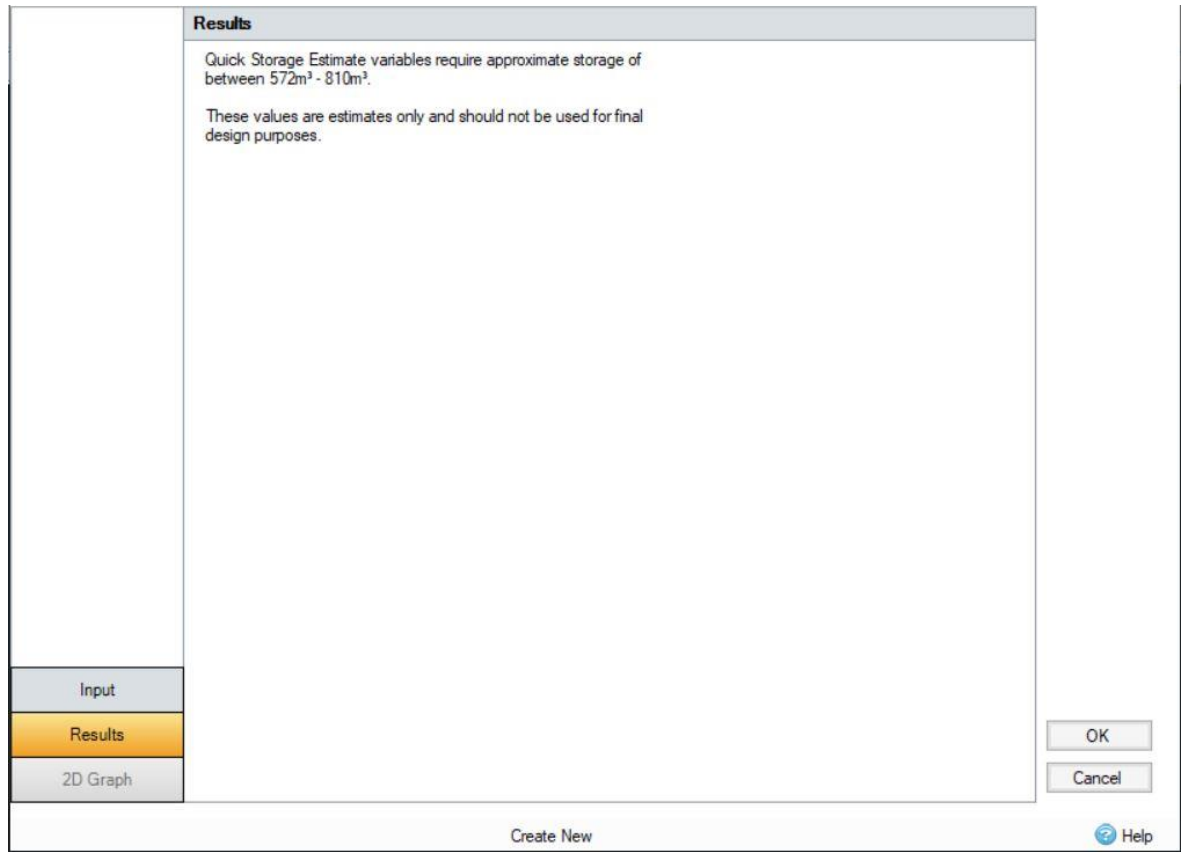

Figure 7 - Infodrainage outputs for 400kV substation area

C Site Characterisation Form

SITE CHARACTERISATION FORM

COMPLETING THE FORM

Note: This form requires the latest version of Adobe Acrobat Reader and on PC's Windows 7 or later. Windows XP produces errors in calculations

Step 1:

Goto Menu Item **File, Save As** and save the file under a reference relating to the client or the planning application reference if available.

Clear Form

Use the **Clear Form** button to clear all information fields.

Notes:

All calculations in this form are automatic.

Where possible information is presented in the form of drop down selection lists to eliminate potential errors.

Variable elements are recorded by tick boxes. In all cases only one tick box should be activated.

All time record fields must be entered in twenty four hour format as follows: HH:MM

All date formats are DD-MM-YYYY.

All other data fields are in text entry format.

This form can be printed out fully populated for submission with related documents and for your files. It can also be submitted by email.

Section 3.2 In this section use an underline _____ across all six columns to indicate the depth at which changes in classification / characteristics occur.

Section 3.4 Lists supporting documentation required.

Section 4 Select the treatment systems suitable for this site and the discharge route.

Section 5 Indicate the system type that it is proposed to install.

Section 6 Provide details, as required, on the proposed treatment system.

APPENDIX A: SITE CHARACTERISATION FORM

File Reference:

1.0 GENERAL DETAILS (From planning application)

Prefix: _____ First Name: Surname:

Address: Site Location and Townland:

Number of Bedrooms: Maximum Number of Residents:

Comments on population equivalent

Proposed Water Supply:

Mains Private Well/Borehole _____ Group Well/Borehole

2.0 GENERAL DETAILS (From planning application)

Soil Type, (Specify Type):

Subsoil, (Specify Type):

Bedrock Type:

Aquifer Category: Regionally Important | Locally Important | Poor

Vulnerability: Extreme High Moderate Low

Groundwater Body: Status

Name of Public/Group Scheme Water Supply within 1 km:

Source Protection Area: ZOC SI SO Groundwater Protection Response:

Presence of Significant Sites (Archaeological, Natural & Historical):

Past experience in the area:

Comments:

(Integrate the information above in order to comment on: the potential suitability of the site, potential targets at risk, and/or any potential site restrictions).

THE SITE IS AN EXISTING BROWNFIELD SITE INDUSTRIAL SITE.

THE PROPOSAL IS TO CARRY OUT AN ASSESSMENT TO DETERMINE THE SITE SUITABILITY TO TREAT AND DISPOSE OF WASTEWATER ON SITE THROUGH GROUNDWATER DISCHARGE.

THE TARGETS AT RISK ARE SURFACEWATERS.

Note: Only information available at the desk study stage should be used in this section.

3.0 ON-SITE ASSESSMENT

3.1 Visual Assessment

Landscape Position:

Slope: Steep (>1:5) Shallow (1:5-1:20) Relatively Flat (<1:20)

Slope Comment

Surface Features within a minimum of 250m (Distance To Features Should Be Noted In Metres)

Houses:

Existing Land Use:

Vegetation Indicators:

Groundwater Flow Direction:

Ground Condition:

Site Boundaries:

3.0 ON-SITE ASSESSMENT

3.1 Visual Assessment (contd.)

Roads:

SITE FRONTS ONTO THE REGIONAL ROAD R400

Outcrops (Bedrock And/Or Subsoil):

NONE

Surface Water Ponding:

NONE

Lakes:

NONE

Beaches/Shellfish Areas:

NONE

Wetlands:

PEATLANDS TO THE REAR OF SITE

Karst Features:

NONE

Watercourses/Streams:*

PEATLANDS TO THE REAR OF SITE

*Note and record water level

3.0 ON-SITE ASSESSMENT

3.1 Visual Assessment (contd.)

Drainage Ditches:*

PEATLANDS TO THE REAR OF SITE

Springs:*

Wells:*

Comments:

(Integrate the information above in order to comment on: the potential suitability of the site, potential targets at risk, the suitability of the site to treat the wastewater and the location of the proposed system within the site).

THE SITE IS A BROWNFIELD SITE. THE FRONT OF THE SITE HAS BEEN INFILLED WITH IMPORTED SOIL TO THE FRONT OF THE ADMINISTRATION BUILDINGS AND YARD.

PROPOSE TO DIG TRIAL HOLES ON THE FRONT GREEN AREA AND TO THE REAR OF THE YARD ADJOINING THE PEATLANDS.

*Note and record water level

3.2 Trial Hole (should be a minimum of 2.1m deep (3m for regionally important aquifers))

To avoid any accidental damage, a trial hole assessment or percolation tests should not be undertaken in areas which are at or adjacent to significant sites, (e.g. NHAs, SACs, SPAs, and/or Archaeological etc.), without prior advice from National Parks and Wildlife Service or the Heritage Service.

Depth of trial hole (m):

Depth from ground surface to bedrock (m) (if present):

Depth from ground surface to water table (m) (if present):

Depth of water ingress:

Rock type (if present):

Date and time of excavation:

Date and time of examination:

Depth of Surface and

Subsurface Percolation Tests	Soil/Subsoil Texture & Classification**	Plasticity and dilatancy***	Soil Structure	Density/ Compactness	Colour****	Preferential flowpaths
0.1 m <input type="text"/>	200MM IMPORTED TOPSOIL 300MM IMPORTED CLAY SUBSOIL			COMPACT	BROWN	NONE
0.2 m <input type="text"/>					LIGHT BROWN	
0.3 m <input type="text"/>	200MM LAYER OF ORIGINAL PEAT SOIL				DARK BROWN	
0.4 m <input type="text"/>						
0.5 m <input type="text"/>	1000MM OF CLAY	THREADS: 5NR RIBBONS: 100mm DILATENT : YES	STRUCTURE LESS MASSIVE	UNCOMPACT/SOFT	GREY BROWN WITH MOTTLING	
0.6 m <input type="text"/>						
0.7 m <input type="text"/>						
0.8 m <input type="text"/>						
0.9 m <input type="text"/>						
1.0 m <input type="text"/>						
1.1 m <input type="text"/>						
1.2 m <input type="text"/>						
1.3 m <input type="text"/>						
1.4 m <input type="text"/>						
1.5 m <input type="text"/>	CLAYgravel	THREADS: 5NR RIBBONS: 100mm DILATENT : YES		UNCOMPACT/SOFT	GREY BROWN	
1.6 m <input type="text"/>						
1.7 m <input type="text"/>						
1.8 m <input type="text"/>						
1.9 m <input type="text"/>						
2.0 m <input type="text"/>						
2.1 m <input type="text"/>						
2.2 m <input type="text"/>						
2.3 m <input type="text"/>						
2.4 m <input type="text"/>						
2.5 m <input type="text"/>	BOTTOM OF TRIAL HOLE AT 3.6					
2.6 m <input type="text"/>						
2.7 m <input type="text"/>						
2.8 m <input type="text"/>						
2.9 m <input type="text"/>						
3.0 m <input type="text"/>						
3.1 m <input type="text"/>						
3.2 m <input type="text"/>						
3.3 m <input type="text"/>						
3.4 m <input type="text"/>						
3.5 m <input type="text"/>						

Likely Subsurface Percolation Value:

Likely Surface Percolation Value:

Note: *Depth of percolation test holes should be indicated on log above. (*Enter Surface or Subsurface at depths as appropriate).
 ** See Appendix E for BS 5930 classification.
 *** 3 samples to be tested for each horizon and results should be entered above for each horizon.
 **** All signs of mottling should be recorded.

3.2 Trial Hole (contd.) Evaluation:

THE TRIAL HOLE WAS EXCAVATED TO 3.6 METRES. THE TRIAL HOLE INDICATED APPROXIMATELY 500MM OF IMPORTED INFILL SOIL ON TOP OF THE EXISTING THIN PEAT LAYER OF 200MM WHICH OVERLAIDS A 1 METRE DEEP CLAY LAYER WITH MOTTLING EVIDENT. UNDER THIS LAYER WAS A CLAYGRAVEL LAYER. PROPOSE TO CARRY OUT SUBSURFACE TESTS IN THIS LAYER.

3.3(a) Subsurface Percolation Test for Subsoil

Step 1: Test Hole Preparation

Percolation Test Hole	1	2	3
Depth from ground surface to top of hole (mm) (A)	1,100	1,100	1,100
Depth from ground surface to base of hole (mm) (B)	1,500	1,500	1,500
Depth of hole (mm) [B - A]	400	400	400
Dimensions of hole [length x breadth (mm)]	300 x 300	300 x 300	300 x 300

Step 2: Pre-Soaking Test Holes

Pre-soak start	Date	18-Jul-2023	18-Jul-2023	18-Jul-2023
	Time	10:30	10:30	10:30
2nd pre-soak start	Date	18-Jul-2023	18-Jul-2023	18-Jul-2023
	Time	16:00	16:00	16:00

Each hole should be pre-soaked twice before the test is carried out.

Step 3: Measuring T_{100}

Percolation Test Hole No.	1	2	3
Date of test	19-07-2023	19-07-2023	19-07-2023
Time filled to 400 mm	10:17	10:19	10:22
Time water level at 300 mm	11:35		10:50
Time (min.) to drop 100 mm (T_{100})	78.00	142.00	28.00
Average T_{100}			82.67

If $T_{100} > 480$ minutes then Subsurface Percolation value >120 – site unsuitable for discharge to ground

If $T_{100} \leq 210$ minutes then go to Step 4;

If $T_{100} > 210$ minutes then go to Step 5;

Step 4: Standard Method (where $T_{100} \leq 210$ minutes)

Percolation Test Hole	1			2			3		
Fill no.	Start Time (at 300 mm)	Finish Time (at 200 mm)	Δt (min)	Start Time (at 300 mm)	Finish Time (at 200 mm)	Δt (min)	Start Time (at 300 mm)	Finish Time (at 200 mm)	Δt (min)
1	11:35	13:43	128.00			0.00	10:50	11:30	40.00
2	13:44	15:58	134.00			0.00	11:32	12:47	75.00
3	15:59	18:12	133.00			0.00	12:50	14:12	82.00
Average Δt Value	131.67			0.00			65.67		
	Average $\Delta t/4 =$ [Hole No.1] <input type="text" value="32.92"/> (t_1)			Average $\Delta t/4 =$ [Hole No.2] <input type="text" value="0.00"/> (t_2)			Average $\Delta t/4 =$ [Hole No.3] <input type="text" value="16.42"/> (t_3)		

Result of Test: Subsurface Percolation Value = (min/25 mm)

Comments:

THE PERCOLATION RATE WAS INCONSISTENT BETWEEN THE HOLES. TEST HOLE 2 HAD A VALUE GREATER 120 WITH VERY LITTLE MOVEMENT AND WAS STILL RETAINING WATER AFTER PRE SOAKING. THERE WAS NO EVIDENCE OF WATER INGRESS INTO THE HOLE AT 3.6 METRES DEEP.

Step 5: Modified Method (where $T_{100} > 210$ minutes)

Percolation Test Hole No.	1					
Fall of water in hole (mm)	Time Factor = T_f	Start Time hh:mm	Finish Time hh:mm	Time of fall (mins) = T_m	$K_{fs} = T_f / T_m$	T-Value = $4.45 / K_{fs}$
300 - 250	8.1			0.00		
250 - 200	9.7			0.00		
200 - 150	11.9			0.00		
150 - 100	14.1			0.00		
Average	T- Value	T- Value Hole 1 = (T_1)		<input type="text" value="0.00"/>		

Percolation Test Hole No.	2					
Fall of water in hole (mm)	Time Factor = T_f	Start Time hh:mm	Finish Time hh:mm	Time of fall (mins) = T_m	$K_{fs} = T_f / T_m$	T-Value = $4.45 / K_{fs}$
300 - 250	8.1			0.00		
250 - 200	9.7			0.00		
200 - 150	11.9			0.00		
150 - 100	14.1			0.00		
Average	T- Value	T- Value Hole 2 = (T_2)		<input type="text" value="0.00"/>		

Result of Test: Subsurface Percolation Value =

(min/25 mm)

Percolation Test Hole No.	3					
Fall of water in hole (mm)	Time Factor = T_f	Start Time hh:mm	Finish Time hh:mm	Time of fall (mins) = T_m	$K_{fs} = T_f / T_m$	T-Value = $4.45 / K_{fs}$
300 - 250	8.1			0.00		
250 - 200	9.7			0.00		
200 - 150	11.9			0.00		
150 - 100	14.1			0.00		
Average	T- Value	T- Value Hole 3 = (T_3)		<input type="text" value="0.00"/>		

Comments:

3.3(b) Surface Percolation Test for Soil

Step 1: Test Hole Preparation

Percolation Test Hole	1	2	3
Depth from ground surface to top of hole (mm)	0	0	0
Depth from ground surface to base of hole (mm)	400	400	400
Depth of hole (mm)	400	400	400
Dimensions of hole [length x breadth (mm)]	300 x 300	300 x 300	300 x 300

Step 2: Pre-Soaking Test Holes

Pre-soak start	Date	18-Jul-2023	18-Jul-2023	18-Jul-2023
	Time	10:05	10:05	10:05
2nd pre-soak start	Date	18-Jul-2023	18-Jul-2023	18-Jul-2023
	Time	16:00	16:00	16:00

Each hole should be pre-soaked twice before the test is carried out.

Step 3: Measuring T_{100}

Percolation Test Hole No.	1	2	3
Date of test	19-Jul-23	19-Jul-23	19-Jul-2023
Time filled to 400 mm	10:14	10:14	10:14
Time water level at 300 mm	11:50	11:41	13:05
Time to drop 100 mm (T_{100})	96.00	87.00	171.00
Average T_{100}			118.00

If $T_{100} > 480$ minutes then Surface Percolation value >90 – site unsuitable for discharge to ground

If $T_{100} \leq 210$ minutes then go to Step 4;

If $T_{100} > 210$ minutes then go to Step 5;

Step 4: Standard Method (where $T_{100} \leq 210$ minutes)

Percolation Test Hole	1			2			3		
Fill no.	Start Time (at 300 mm)	Finish Time (at 200 mm)	ΔT (min)	Start Time (at 300 mm)	Finish Time (at 200 mm)	ΔT (min)	Start Time (at 300 mm)	Finish Time (at 200 mm)	ΔT (min)
1			0.00			0.00			0.00
2			0.00			0.00			0.00
3			0.00			0.00			0.00
Average ΔT Value	0.00			0.00			0.00		
	Average $\Delta T/4 =$ [Hole No.1] 0.00 (T_1)			Average $\Delta T/4 =$ [Hole No.2] 0.00 (T_2)			Average $\Delta T/4 =$ [Hole No.3] 0.00 (T_3)		

Result of Test: Surface Percolation Value = 0.00 (min/25 mm)

Comments:

THE WATER IN THE 3 TEST HOLES DROPPED MARGINALLY OVER SEVERAL HOUR AFTER THE FIRST 100MM DROP. THE FIRST 100MM IS ACCOUNTED FOR DUE TO HTE IMPORTED TOPSOIL. BELOW THIS TOPLAYER IS A CLAY SUBSOIL.

Step 5: Modified Method (where $T_{100} > 210$ minutes)

Percolation Test Hole No.	1					
Fall of water in hole (mm)	Time Factor = T_f	Start Time hh:mm	Finish Time hh:mm	Time of fall (mins) = T_m	$K_{fs} = T_f / T_m$	T-Value = $4.45 / K_{fs}$
300 - 250	8.1			0.00		
250 - 200	9.7			0.00		
200 - 150	11.9			0.00		
150 - 100	14.1			0.00		
Average	T- Value	T- Value Hole 1 = (T_1)		0.00		

Percolation Test Hole No.	2					
Fall of water in hole (mm)	Time Factor = T_f	Start Time hh:mm	Finish Time hh:mm	Time of fall (mins) = T_m	$K_{fs} = T_f / T_m$	T-Value = $4.45 / K_{fs}$
300 - 250	8.1			0.00		
250 - 200	9.7			0.00		
200 - 150	11.9			0.00		
150 - 100	14.1			0.00		
Average	T- Value	T- Value Hole 2 = (T_2)		0.00		

Result of Test: Surface Percolation Value = 0.00 (min/25 mm)

Percolation Test Hole No.	3					
Fall of water in hole (mm)	Time Factor = T_f	Start Time hh:mm	Finish Time hh:mm	Time of fall (mins) = T_m	$K_{fs} = T_f / T_m$	T-Value = $4.45 / K_{fs}$
300 - 250	8.1			0.00		
250 - 200	9.7			0.00		
200 - 150	11.9			0.00		
150 - 100	14.1			0.00		
Average	T- Value	T- Value Hole 3 = (T_3)		0.00		

Comments:

3.4 The following associated Maps, Drawings and Photographs should be appended to this site characterisation form.

1. Discovery Series 1:50,000 Map indicating overall drainage, groundwater flow direction and housing density in the area.
2. Supporting maps for vulnerability, aquifer classification, soil, subsoil, bedrock.
3. North point should always be included.
4. (a) Scaled sketch of site showing measurements to Trial Hole location and
 - (b) Percolation Test Hole locations,
 - (c) wells and
 - (d) direction of groundwater flow (if known),
 - (e) proposed house (incl. distances from boundaries)
 - (f) adjacent houses,
 - (g) watercourses,
 - (h) significant sites
 - (i) and other relevant features.
5. Site specific cross sectional drawing of the site and the proposed layout¹ should be submitted.
6. Photographs of the trial hole, test holes and site including landmarks (date and time referenced).
7. Pumped design must be designed by a suitably qualified person.

¹ The calculated percolation area or polishing filter area should be set out accurately on the site layout drawing in accordance with the code of practice's requirements.

4.0 CONCLUSION of SITE CHARACTERISATION

Integrate the information from the desk study and on-site assessment (i.e. visual assessment, trial hole and percolation tests) above and conclude the type of system(s) that is (are) appropriate. This information is also used to choose the optimum final disposal route of the treated wastewater.

Slope of proposed infiltration / treatment area:

Are all minimum separation distances met?

Depth of unsaturated soil and/or subsoil beneath invert of gravel (or drip tubing in the case of drip dispersal system)

Percolation test result: Surface: Sub-surface:

Not Suitable for Development
i.e not suitable for discharge to ground

Suitable for Development

Identify all suitable options

1. Septic tank system (septic tank and percolation area) **(Chapter 7)**
2. Secondary Treatment System **(Chapters 8 and 9)** and soil polishing filter **(Section 10.1)**
3. Tertiary Treatment System and treatment area **(Section 10.2)**

Discharge Route ¹

Tricel package waste water treatment system (or equivalent). Specification is as follows

- Maxius 60m5000x2 with P-dosing
- 2600 Pump chamber with dual domo 15
- Sandcel 9000

Treated liquid from system will be discharged to process water holding tank where it will then be discharged to a water course

5.0 SELECTED DWWTS

Propose to install:

and discharge to:

Invert level of the trench/bed gravel or drip tubing (m)

Site Specific Conditions (e.g. special works, site improvement works testing etc.)

Refer to appendix 11B of the main site investigation report by Irish Drilling Ltd. Tricel Maxus system (or equivalent) containing a Mars 5000 x 2 system followed by a 9,000l, 150m² sand polishing filter. The system includes a minimum 10,800l primary settlement and buffer tank which would then feed the 2 Mars 5,000l treatment plant. The treated liquid is pumped from the Mars units to the Sandcel system for tertiary treatment. The treated liquid is then collected and discharged to the process water tank before being discharged to a watercourse.

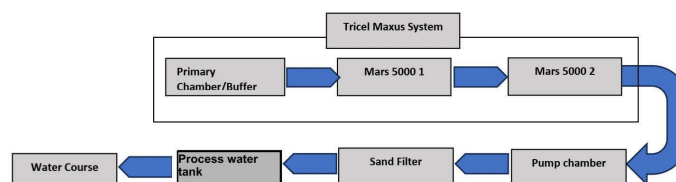

¹ A discharge of sewage effluent to "waters" (definition includes any or any part of any river, stream, lake, canal, reservoir, aquifer, pond, watercourse or other inland waters, whether natural or artificial) will require a licence under the Water Pollution Acts 1977-90. Refer to Section 2.4.

6.0 TREATMENT SYSTEM DETAILS

SYSTEM TYPE: Septic Tank Systems (Chapter 7)

Tank Capacity (m ³) <input style="width: 80%;" type="text"/>	Percolation Area	Mounded Percolation Area
	No. of Trenches <input style="width: 80%;" type="text"/>	No. of Trenches <input style="width: 80%;" type="text"/>
	Length of Trenches (m) <input style="width: 80%;" type="text"/>	Length of Trenches (m) <input style="width: 80%;" type="text"/>
	Invert Level (m) <input style="width: 80%;" type="text"/>	Invert Level (m) <input style="width: 80%;" type="text"/>

SYSTEM TYPE: Secondary Treatment System (Chapters 8 and 9) and polishing filter (Section 10.1)

Secondary Treatment Systems receiving septic tank effluent (Chapter 8)

Media Type	Area (m ²)*	Depth of Filter	Invert Level
Sand/Soil	<input style="width: 80%;" type="text"/>	<input style="width: 80%;" type="text"/>	<input style="width: 80%;" type="text"/>
Soil	<input style="width: 80%;" type="text"/>	<input style="width: 80%;" type="text"/>	<input style="width: 80%;" type="text"/>
Constructed Wetland	<input style="width: 80%;" type="text"/>	<input style="width: 80%;" type="text"/>	<input style="width: 80%;" type="text"/>
Other	<input style="width: 80%;" type="text"/>	<input style="width: 80%;" type="text"/>	<input style="width: 80%;" type="text"/>

Packaged Secondary Treatment Systems receiving raw wastewater (Chapter 9)

Type	<input style="width: 95%;" type="text" value="Maxius 60m5000x2 with P-dosing"/>
Capacity PE	<input style="width: 80%;" type="text" value="60"/>
Sizing of Primary Compartment	<input style="width: 80%;" type="text" value="23.00"/> m ³

Polishing Filter*: (Section 10.1)

Surface Area (m ²)*	<input style="width: 95%;" type="text" value="150.00"/>	Option 3 - Gravity Discharge Trench length (m)	<input style="width: 95%;" type="text"/>
Option 1 - Direct Discharge Surface area (m ²)	<input style="width: 95%;" type="text"/>	Option 4 - Low Pressure Pipe Distribution Trench length (m)	<input style="width: 95%;" type="text"/>
Option 2 - Pumped Discharge Surface area (m ²)	<input style="width: 95%;" type="text"/>	Option 5 - Drip Dispersal Surface area (m ²)	<input style="width: 95%;" type="text"/>

SYSTEM TYPE: Tertiary Treatment System and infiltration / treatment area (Section 10.2)

Identify purpose of tertiary treatment

Provide performance information demonstrating system will provide required treatment levels

Provide design information

Improve effluent quality.

Refer to attached Tricel documentation.

Refer to attached Tricel documentation.

DISCHARGE ROUTE:

Groundwater	<input type="checkbox"/>	Hydraulic Loading Rate * (l/m ² .d)	<input style="width: 80%;" type="text"/>	Surface area (m ²)	<input style="width: 80%;" type="text"/>
Surface Water **	<input checked="" type="checkbox"/>	Discharge Rate (m ³ /hr)	Discharged in combination with process water. Final figures at detailed design		

* Hydraulic loading rate is determined by the percolation rate of subsoil

** Water Pollution Act discharge licence required

6.0 TREATMENT SYSTEM DETAILS

QUALITY ASSURANCE:

Installation & Commissioning

Installation to be supervised by a competent individual with professional indemnity insurance.

On-going Maintenance

De-sludging of the tank to be as per manufacturers requirements.

7.0 SITE ASSESSOR DETAILS

Company:

Prefix:

First Name:

Surname:

Address:

Qualifications/Experience:

Date of Report:

Phone:

E-mail:

Indemnity Insurance Number:

Signature: _____

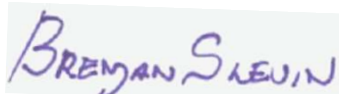







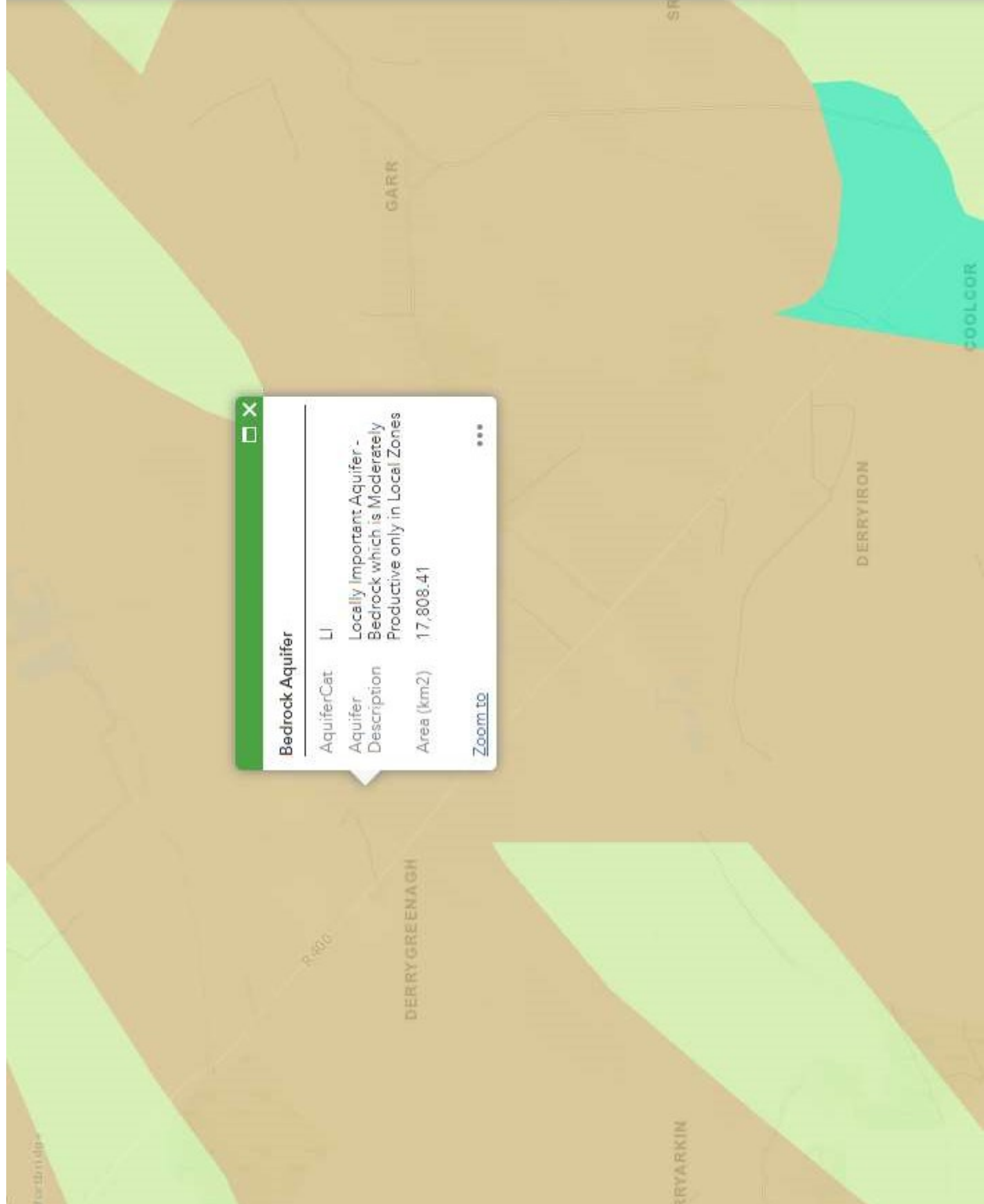



- ▶ Bedrock Geology 1 Million
- ▶ Bedrock Geology 500k
- ▶ Bedrock 100k Sections
- ▶ Bedrock Geology 100k
- ▶ Groundwater Drinking Water Protection
- ▶ Groundwater Catchment and WFD Management Units
- ▶ Groundwater Resources (Aquifers)
- ▶ Groundwater Bedrock Geology
- ▶ Groundwater Recharge
- ▶ Groundwater Vulnerability
- ▶ Groundwater Subsoil Permeability
- ▶ Teagasc Soils
- ▶ INFOMAR Bathymetry (Water Depth Seafloor) 10m
- ▶ INFOMAR Bathymetry (Water Depth Seafloor) 25m
- ▶ INFOMAR Bathymetry (Water Depth Seafloor) 100m
- ▶ OSI Boundaries
- ▶  Bedrock100k_Seamless_2018 - BEDROCK.Lexicon_Polygons_2018
- ▶  Bedrock100k_Seamless_2018 - BEDROCK.Lexicon_Linework_2018

Layers

- Geological Heritage Audited Sites
- Geological Heritage Unaudited Sites
- Mineral Exploration Boreholes
- Verified Boreholes Logs
- Borehole Locations (Unverified)
- Mineral Localities
- Active Quarries
- Groundwater Karst Data
- Groundwater Wells and Springs
- Landslide Events
- EXT GSI Geotechnical Boreholes
- EXT GSI Geotechnical Sites
- Quaternary Sediments
- Bedrock Geology 1 Million
- Bedrock Geology 500k
- Bedrock 100k Sections

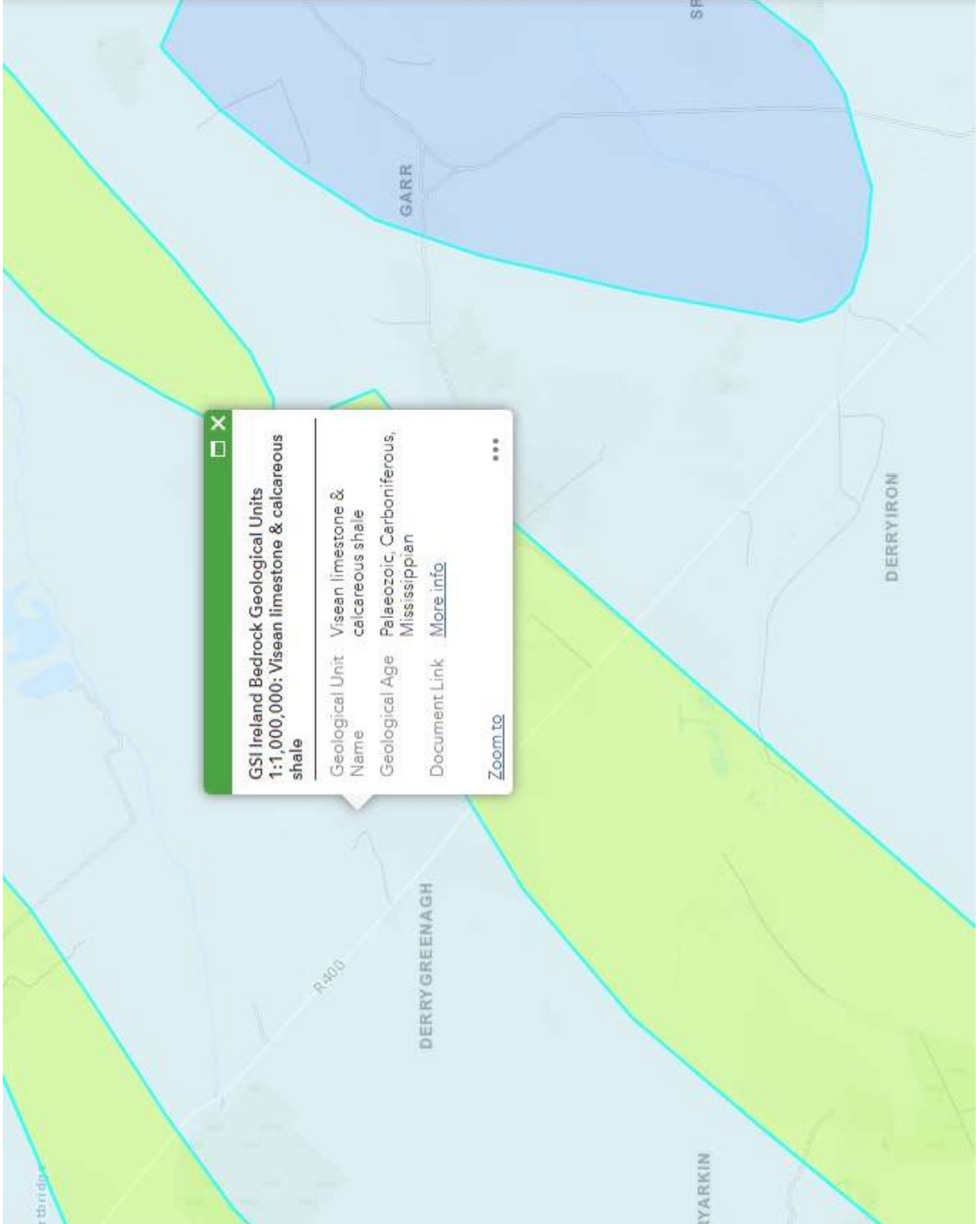

- EXT GSI Geotechnical Borehole
- EXT GSI Geotechnical Sites
- Quaternary Sediments
- Bedrock Geology 1 Million
- Bedrock Geology 500k
- Bedrock 100k Sections
- Bedrock Geology 100k
- Groundwater Drinking Water Protection
- Groundwater Catchment and Management Units
- Groundwater Resources (Aquifers)
- Groundwater Bedrock Geology
- Groundwater Recharge
- IE GSI Groundwater Recharge (ROI) ITM
- Groundwater Vulnerability
- Groundwater Subsoil Permeability
- Teagasc Soils
- INFOMAR Bathymetry (Water Depth) 10m Seafloor

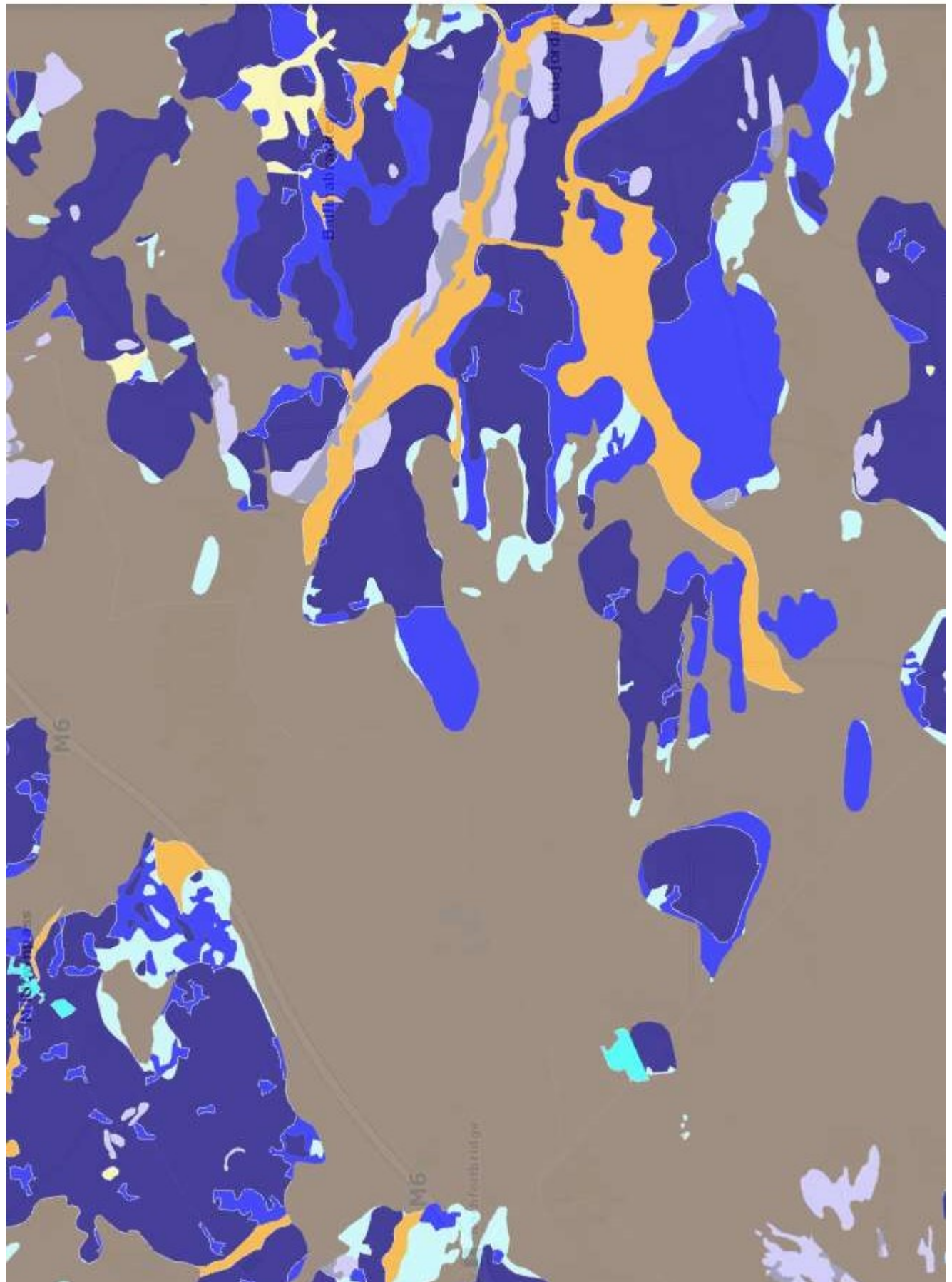

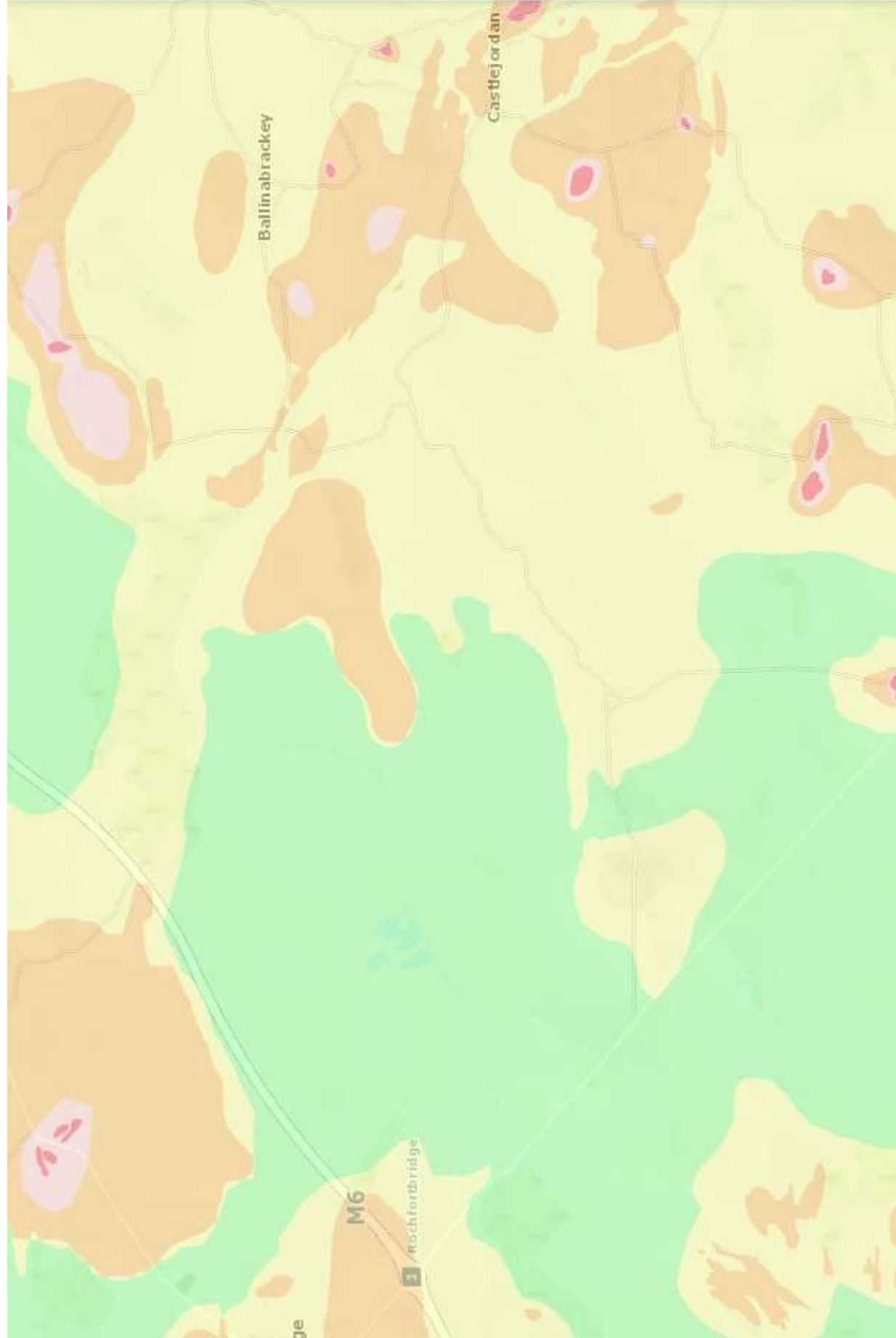

- Quaternary Sediments
- Bedrock Geology 1 Million
- Bedrock Geology 500k
- Bedrock 100k Sections
- Bedrock Geology 100k
- Groundwater Drinking Water
- Groundwater Catchment and Management Units
- Groundwater Resources (A)
- Groundwater Bedrock Geology
- Groundwater Recharge
- IE GSI Groundwater Recharge (RO) ITM
- Groundwater Vulnerability
- Groundwater Subsoil Permeability
- Teagasc Soils
- INFOMAR Bathymetry (Water Seafloor) 10m

ENGINEERING  CONSULTING

FICHTNER

Consulting Engineers Limited

77 Sir John Davidson Quay, Block C,
Grand Canal Docklands, Dublin 2, D02 VK60,
Ireland

t: +353 (1)582 7151

www.fichtner.co.uk