

# **Proposed Derrygreenagh Power Project Environmental Impact Assessment Report**

## **Chapter 5: The Proposed Development and Overall Project**

Prepared for:  
Bord na Móna Powergen Limited.  
Main Street,  
Newbridge,  
Co. Kildare  
W12 XR59  
Ireland

Prepared by:  
AECOM  
4<sup>th</sup> Floor, Adelphi Plaza  
Georges Street Upper  
Dun Laoghaire  
Co. Dublin  
A96 T927

T: +353 (0) 1 238 3100  
aecom.com

© 2023 AECOM Limited. All Rights Reserved.

This document has been prepared by AECOM Limited ("AECOM") for sole use of our client (the "Client") in accordance with generally accepted consultancy principles, the budget for fees and the terms of reference agreed between AECOM and the Client. Any information provided by third parties and referred to herein has not been checked or verified by AECOM, unless otherwise expressly stated in the document. No third party may rely upon this document without the prior and express written agreement of AECOM.

## 5.0 THE PROPOSED DEVELOPMENT AND OVERALL PROJECT

### 5.1 Introduction

- 5.1.1 This chapter of the Environmental Impact Assessment Report (EIAR) provides a detailed description of the 'Proposed Development' for which planning consent is being sought, comprising a Power Plant Area with Combined Cycle Gas Turbine (CCGT) and Open Cycle Gas Turbine (OCGT) plant and associated infrastructure, Electricity Grid Connection including substations, associated buildings and transmission infrastructure ('Proposed Development'). The Proposed Development is located entirely within Co. Offaly, primarily on land within a subset of the Derrygreenagh bog group, with the exception of agricultural land required for a loop-in connection to the Oldstreet-Woodland 400kV line. A connection to the high-pressure gas network will be required as part of the Overall Project. A Gas Connection Corridor has been considered as part of the 'Overall Project' (as defined below and in Chapter 1 of this EIAR has been identified by Gas Networks Ireland as the preferred route at the time of writing).
- 5.1.2 The Gas Connection Corridor, which runs from the Dublin-Galway high pressure gas network (BGE/77) to the Power Plant Area, is not included as part of this planning application but is integral to the Overall Project and so is considered throughout the EIAR in so far as reasonably practicable. The Gas Connection Corridor may be subject to change during the detailed design and consenting process to be carried out by Gas Networks Ireland (GNI), but the preferred route, at the time of writing, has been considered (please refer to Chapter 1: Introduction for more detail on site selection process and identification of this preferred route by GNI). The Gas Connection Corridor is located in the counties of Westmeath and Offaly.
- 5.1.3 Details and a statement (a 'statement of competence') of the relevant expertise and qualifications of the author to the EIAR is required by EIA Regulations. In accordance with EIA Regulations and EPA Guidelines, AECOM confirms that experts involved in the preparation of this EIAR are fully qualified and competent in their respective fields and details of each relevant expert are presented in **Appendix 1B** (refer to EIAR Volume II).
- 5.1.4 This chapter of the EIAR has been written by Peter O'Connor, Technical Director at AECOM - full detail of expertise and qualifications is available in Appendix 1B.
- 5.1.5 For the purposes of this EIAR, the following terms are used to describe the Proposed Development and its wider project context (including the Overall Project):
- **'Proposed Development'** – relates to the components for which planning permission is being sought (i.e., the 'red line boundary') – this includes the Power Plant Area and Electricity Grid Connection as defined below.
  - **'Power Plant Area'** – relates to the main thermal power plant area east of the R400 road, which includes Combined Cycle Gas Turbine (CCGT) and Open Cycle Gas Turbine (OCGT) plant; a gas Above Ground Installation (AGI) ('Derrygreenagh AGI'); water abstraction and water treatment infrastructure; respective surface and process water discharge connection routes; and a permanent peat and spoil deposition area for overburden material excavated from the Power Plant Area. The process water discharge pipe will extend west of the R400 road before ultimate discharge south into the Yellow River.
  - **'Industrial Emissions Licence Area'** - relates to a sub boundary within the Power Plant Area required for the operational phase under Class activity 2.1 of the First Schedule of the EPA Act as amended and excludes components such as the Derrygreenagh AGI and requirements limited to the construction phase, namely

upgrades to the public road network and peat deposition area. While the Industrial Emissions Licence Area will likely comprise a smaller area within the footprint of the Power Plant Area once operational, for the purposes of this EIAR, the entirety of the wider Power Plant Area has been considered in respect of the overall assessments of the construction, operational and decommissioning phases, for completeness.

- **‘Electricity Grid Connection’** - this is part of the Proposed Development and will consist of the 220kV substation west of the R400 road, pylon towers, overhead lines, Line-cable Interface compound, underground cabling, associated cabling and a new loop-in 400kV substation and compound.
- **‘Gas Connection Corridor’** - this is part of the Overall Project, as defined below, and will enable the Proposed Development to connect to the existing high pressure Gas Pipeline to the West (BGE/77), north of the Power Plant Area via an AGI at the tie-in location and an underground pipeline. The underground gas connection is not being applied for in the planning application for the Proposed Development (as it will be applied for by Gas Networks Ireland (GNI) under separate consenting processes). However, the Gas Connection Corridor, identified by GNI during the preliminary design stage is assessed in this EIAR as part of the Overall Project for completeness, as it will be integral to the operation of the Proposed Development. The route of the Gas Connection Corridor is the preferred route, as indicated by GNI, at the time of writing but may be subject to change as part of the detailed design process to be carried out.
- **‘the Overall Project’** – relates to the Proposed Development (*i.e.* the components for which planning permission is being sought) and, to ensure a robust environmental assessment, includes the Gas Connection Corridor as described above.
- **‘Secondary Fuel’** – While the Power Plant Area, once operational, will run primarily on natural gas supplied by GNI through the Gas Connection Corridor, the plant will also have dual fuel capability for firing off secondary fuel stored onsite. This ‘Secondary Fuel’ will comprise of either Distillate and/or HVO.

5.1.6 This chapter of the EIAR is supported by the following Figures (refer to EIAR Volume II, Appendix 5C) which detail the Proposed Development layout and design (**Note:** Full scale drawings have been included in the planning submission accompanying the EIAR. All drawings included in the EIAR Chapter 5: The Proposed Development have been included at A3 page size for reference).



## 5.2 Overview of the Proposed Development and Overall Project

- 5.2.1 The Applicant is primarily a climate solutions company and is developing renewable energy projects (wind, solar, biomass and biogas) across its landbank to make a significant contribution to Ireland's ambitious targets for net zero greenhouse gas emissions by 2050. Bord na Móna is seeking to contribute towards the target of increasing the proportion of renewable electricity to 80% by 2030, through accelerating the development of renewable energy by providing up to 2GW of renewable energy generating assets by 2030 in support of national climate and energy policy targets.
- 5.2.2 The Applicant intends to develop out flexible, fully dispatchable gas-fired technology at its site in Derrygreenagh for the production of electrical power for export to the National high voltage transmission grid. This development will support the intermittent nature of renewable energy generation and the security of the electrical grid network by providing for the replacement of older conventional power systems with lower carbon gas-fired technology. The Proposed Development will have capability to operate off renewable gas blends, including biomethane and hydrogen, from supply chains that are expected to be developed in the future, in accordance with the Hydrogen Strategy for Ireland.
- 5.2.3 The power plant has been designed in accordance with Best Available Techniques (BAT) for Large Combustion Plant (LCP) (Commission Implementing Decision (EU) 2021/2326. The Power Plant Area includes both CCGT and OCGT technology, which will operate primarily off natural gas with dual fuel capability for firing off back-up Secondary Fuel stored onsite.
- 5.2.4 The OCGT process operates on the Brayton thermodynamic cycle in order to produce electricity. Air for the gas turbine is drawn in from the atmosphere across an intake filter where it enters the compressor. The air is then compressed through a multistage axial flow compressor to the final pressure required for combustion. Upon exiting the compressor, the compressed air enters the combustion chamber where it is mixed with fuel, either natural gas or secondary fuel, and ignited. The energy contained in the fuel-air mixture is released through the process of combustion with the resulting hot combustion gases expanding through a turbine. This provides the mechanical power to drive the turbine compressor section and the attached electrical generator, where it is converted to electrical energy. The exhaust gases exiting the gas turbine are discharged to atmosphere via an exhaust stack.
- 5.2.5 The CCGT process consists of two thermodynamic cycles, the Brayton thermodynamic cycle and Rankine cycles working together to produce electricity through a combined cycle. The process will operate off a 'single shaft' arrangement consisting of gas turbine, steam turbine and generator arranged on a single shaft or power train. It is possible to generate approximately 50% more power output through capturing heat from hot exhaust gases (otherwise discharged to atmosphere in the OCGT) to create steam from water in the Heat Recovery Steam Generator (HRSG) to power a steam turbine generator to produce electricity.
- 5.2.6 The plant units will comply with requirements of CO<sub>2</sub> emission limits as detailed in the Electricity Regulation (EU) 2019/943, Article 22 paragraph 4 and the requirements of BAT for LCP (2021/2326/EU) in both OCGT and CCGT plants.
- 5.2.7 Electrical outputs from generating assets (i.e. OCGT and CCGT plant) will be fed to transformers where the voltage will be stepped up to 220kV. The power will be transferred via underground cables linking the Power Plant Area (east of R400 road) to the Electricity Grid Connection 220kV substation (west of the R400 road) via an existing road underpass along the former light railway line.

- 5.2.8 The Electricity Grid Connection has been designed in accordance with EirGrid Transmission policies and requirements. The connection method is a new 220kV substation with associated transmission system in the form of a 220kV double circuit hybrid transmission infrastructure, comprising of c. 5km of overhead line (OHL) and c. 3.4km of underground cable (UGC), which will connect to a new 400kV substation which will connect into the national grid (400kV Oldstreet-Woodland overhead transmission line) via a loop-in connection. The proposed 400kV substation will consist of a 4-bay C-type design and is located adjacent to the existing 400kV Oldstreet-Woodland overhead transmission line. The transfer from OHL to UGC will be facilitated by a line-cable interface compound (please refer to drawing BNM-DPS-E-1005 for detail). The proposed connection method is due to significant suitable aligned with the requirements as set out by EirGrid for the connection point into of the facility to the national grid network (i.e. Oldstreet-Woodland 400kV).
- 5.2.9 The Gas Connection Corridor will contain the underground gas connection pipe to be constructed between the Gas Pipeline to the West (BGE/77) and the Derrygreenagh AGI in the Power Plant Area and includes a requirement for an AGI on the high-pressure pipeline c. 9.6km to the north of the Power Plant Area. The Gas Connection Corridor is part of the Overall Project. The Gas Connection Corridor is not being applied for as part of the planning application for the Proposed Development as the connection will be subject to a separate future consenting process to be carried out by Gas Networks Ireland. However, the preferred Gas Connection Corridor at the time of writing, as indicated by GNI, is assessed throughout this EIAR as part of the Overall Project, due to the integral nature of this connection to facilitate the operation of the Proposed Development. The preferred Gas Connection Corridor is 1km wide and traverses through public road network (c. 1.4km to be routed within the R400 road) and agricultural land (c. 9.6km total in length) to the west of Rochfortbridge. The Gas Connection Corridor will require crossing of 2 no. local roads, 1 no. regional road, the M6 motorway, and will cross 2 no. streams. The route of the Gas Connection Corridor considered within this assessment has been determined by GNI following the identification of technical and environmental constraints.
- 5.2.10 The Proposed Development is located in the townlands of Knockdrin, Derrygreenagh, Derryarkin, Derryiron, Ballybeg, Coolcor, Barrysbrook, Clonin, Togher and Coole.
- 5.2.11 A full description on the existing baseline environment of the Proposed Development and Overall Project is included in Chapter 4 of this EIAR. The Power Plant Area is approximately 49 hectares and will be located predominantly on the site of the existing Derrygreenagh Works east of the R400 road (refer to Drawing S7060-8050-0039 for further detail on the location of the Power Plant Area). The Electricity Grid Connection is approximately 263 hectares in total and will be located largely to the south of the Power Plant Area, predominantly within the bogs of Derryarkin and Ballybeg (refer to Drawing S7060-8050-0055 for further detail on the location of the Electricity Grid Connection). The total area of the Proposed Development (the 'red line' planning application area) is c.308 hectares.
- 5.2.12 The Gas Connection Corridor, assessed for the purposes of this EIAR, is approximately 970 hectares in total in the townlands of Derrygreenagh, Farthingstown, Castlelost, Castlelost West, Kilbrennan and Calverstown.
- 5.2.13 The construction, operation and subsequent decommissioning phase of the Proposed Development and Overall Project is presented in this chapter. A Construction and Environmental Management Plan (CEMP) has been prepared to accompany this planning application. The CEMP will remain a live working document throughout the planning and post-planning process and will be updated and reviewed by the

Engineering, Procurement and Construction (EPC) contractor upon appointment to reflect planning conditions and input from the local authority post consent. The construction programme is presented within Section 5.5 which includes all key stages and milestones and provides a robust basis for assessment purposes.

- 5.2.14 With regard to the operational phase, it is envisaged that the Industrial Emissions Licence Area (located in the Power Plant Area) will have a design life of 25 years, while the Electricity Grid Connection and Gas Connection Corridor will be managed by the respective transmission asset operators (TAO) and transmission service operators (TSO) (GNI for gas and ESBN and EirGrid for electricity); as part of the national grid electricity and gas networks. For the purpose of this environmental assessment, the lifetime of the Power Plant Area is estimated as 25 years and this is based on the design life of the equipment proposed. The operational requirements of the Power Plant Area will inevitably change during its design life, and it will be subject to regular reviews to identify potential modifications and amendments that would allow the asset to have a future sustainable use beyond 25 years. Such modifications may occur within or beyond the 25-year period and may include:
- Substitution or dilution of natural gas with an alternative fuel such as hydrogen or biofuel; or
  - modification to the operational characteristics to allow the Power Plant Area to meet new or alternative power generation/environmental requirements at that point in time.
- 5.2.15 At the end of the design life, the Power Plant Area would either be decommissioned, or the lifetime could potentially be extended (any extension would be subject to a new planning application). Decommissioning or extension of the lifetime of the asset would therefore be expected to commence at some point after 2052.
- 5.2.16 The plant design will enable transition to hydrogen use in the future (i.e. it will be hydrogen capable). The proposed thermal plant has the capability of operating on up to 5% hydrogen blends without modifications. The plant has been optimally designed to facilitate transition to blends of higher substitution rates of natural gas with modifications in accordance with commitments in the Hydrogen Strategy to decarbonise the gas network.
- 5.2.17 The plant design is also capable of transitioning from natural gas to a mixture of natural gas and biomethane, subject to future fuel mixtures which may be introduced into the gas network by GNI, without any technical modification.

### 5.3 Components of the Proposed Development and Overall Project- Overview

- 5.3.1 The purpose of this EIAR chapter is to provide further detail on the various components of the Proposed Development and Overall Project including structures and infrastructure. All of the various components which make up the Proposed Development are contained within the application area shown on the Proposed Development Plan (refer to drawing S7060-8050-0040, EIAR Volume II, Appendix 5C) and are described or encompassed within the description of the Proposed Development in the accompanying planning application documents and Planning Statement.
- 5.3.2 The Gas Connection Corridor assessed as part of the Overall Project is shown on the Overall Development Plan. As previously stated, the final route and detailed design of the Gas Connection will be subject to a separate consenting application process, which will be undertaken by GNI, and may be subject to change.
- 5.3.3 The location of the main study areas/components of the Proposed Development and Overall Project are presented below in Plate 5.1

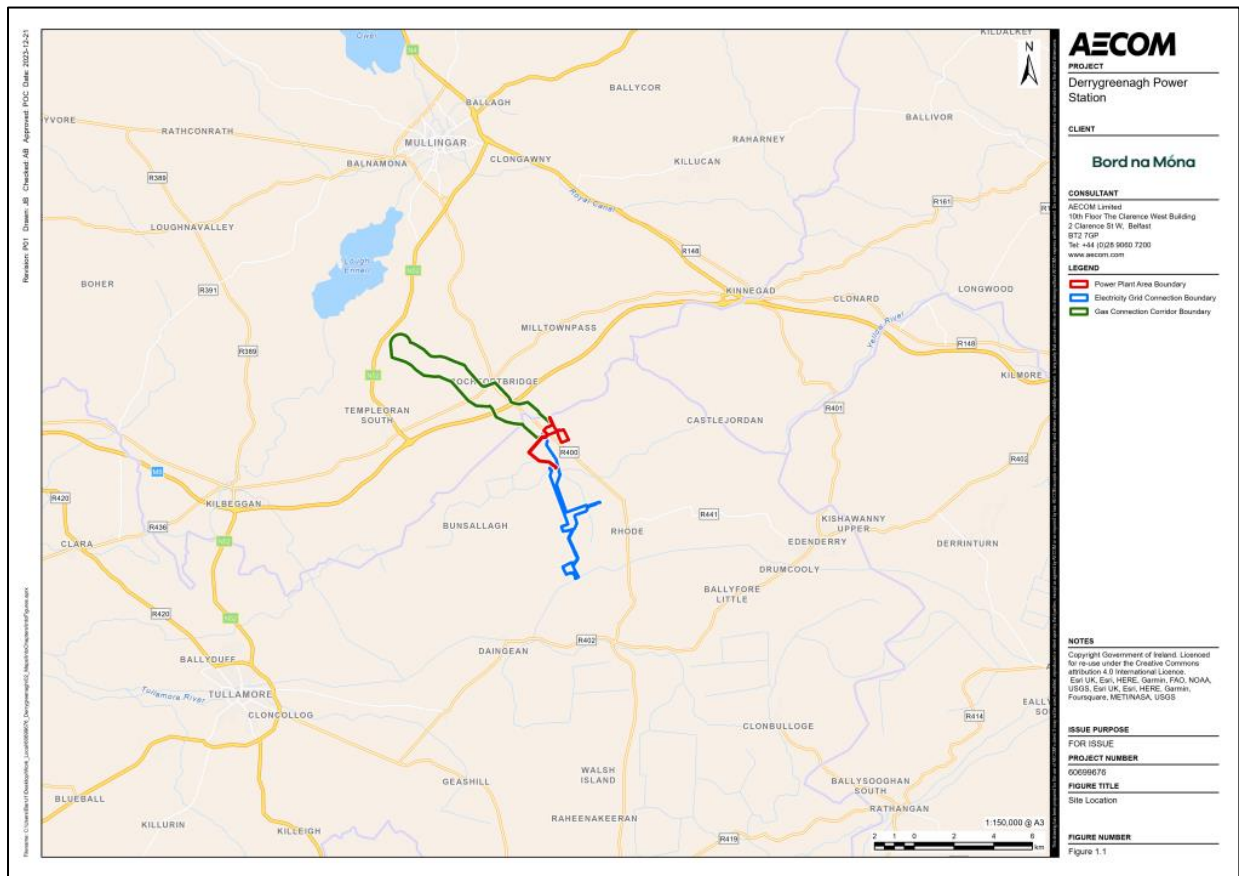

**Plate 5.1: Main Components and Study Areas for the Proposed Development and Overall Project**

Power Plant Area (part of the Proposed Development) - Overview

5.3.4 The Proposed Development will include the following components in relation to the Power Plant Area (which are presented in detail below in Section 5.4) as per Table 5.1 below:

**Table 5. 1 : Power Plant Area (part of the Proposed Development) Components**

<b>PROPOSED ELEMENT</b>	<b>COMPONENT / DETAILS</b>
Combined Cycle Gas Turbine (CCGT) Plant	CCGT Turbine Hall and buildings
	Heat Recovery Steam Generator (HRSG) and associated cladding
	1 no. Emissions Stack (CCGT) 60m high and CEMS monitoring station and platforms
	Air Cooled Condensers (ACC)
	Air Intake (CCGT)
Open Cycle Gas Turbine (OCGT) Plant	OCGT Turbine Hall and Buildings
	Air Intake (OCGT)
	Emissions Stack (OCGT) 45m high
Secondary Fuel Storage and Unloading Facility	2 No. Fuel Storage Tanks and unloading area
	Fuel pumping and cleaning plant
	Fuel transfer system
Subsidiary items of plant/equipment	Blowdown Tank
	Boiler Feed pumps
	Turbine blowdown tank
	Drains recovery tank
	Deaerator and feedwater storage tank
	Auxiliary Boiler
	Propane Ignition System
	Transformer Cooling Banks
	Emergency Diesel Generator
	Firefighting systems
	Fire Suppression Skid
	2 No. Ammonia storage tanks
	Raw/Fire Water Tank
	Process water treatment & pre-treatments infrastructure including water abstraction and discharge
	2 No. Demineralised water tanks
	Main and Auxiliary Transformers
	Silencers, vents and drains
	Underground/Overground Services (gas, sewage, process water, storm water drainage, water, secondary fuel, electrical services distribution etc.)
Fuel Gas Performance Heater	



PROPOSED ELEMENT	COMPONENT / DETAILS
	Associated ancillary equipment
Gas Connection Above Ground Infrastructure (AGI) Compound	Regulator building
	Boiler and instrumentation houses
	Gas analyser kiosk
	Pressure reduction system
	Security fencing and Boundary Treatment (gates)
	AGI Site Access - The AGI compound will be served by access point off the R400 road which also serves the power plant area.
Gas receiving facility	Gas compressor building
	Fin fan coolers
	Pressure reducing station
Associated buildings and infrastructure	Administration Building
	Workshop
	Control Room
	Stores
	Car Parking
	Maintenance Compounds
	Abstraction wells
	Water Treatment Plant
	Process Wastewater Treatment Plant
	Foul Water Treatment System
	Surface water drainage attenuation
	Water Discharge Points
	Firewater Retention and Shutdown Facility
	Power Plant Area Site Access and Internal roads
	External lighting
	Security fencing and Boundary Treatment(gates)
Utilities (pipes, cables, surface water drainage systems, oil- water separators, including channelling, culverting, crossings etc.)	
Landscape Mitigation	
Demolition works	Demolition of a number of existing buildings and structures within the existing Derrygreenagh Works site is included in the Temporary Construction Phase Works. While the effects of the demolition will be permanent, the works activity will be temporary and related to site preparation.
Peat Deposition Area / Soil Deposition Area	Permanent storage of peat or soil from excavations as a result of the construction phase of the Power Plant Area. The peat and soil deposition area will not exceed 1m above ground level and will be suitably profiled to eliminate risk of movement or slippage of material.

PROPOSED ELEMENT	COMPONENT / DETAILS
Temporary Construction Phase Works	<p>The Power Plant Area element of the Proposed Development will include the following Temporary Construction Phase Works:</p> <ul style="list-style-type: none"> <li>Temporary Contractor compounds and welfare facilities</li> <li>Temporary facilities and stores</li> <li>Temporary vehicle parking facilities for construction phase</li> <li>Temporary security fencing and gates</li> <li>Temporary external lighting</li> <li>Temporary Signage and Traffic Management</li> </ul>

Electricity Grid Connection (part of the Proposed Development) - Overview

5.3.5 The Proposed Development will include the following components in relation to the Electricity Grid Connection (which are presented in detail below in Section 5.5) as per Table 5.2 below:

**Table 5. 2: Electricity Grid Connection (part of the Proposed Development) Components**

PROPOSED ELEMENT	COMPONENT / DETAILS
220kV Substation	Hybrid gas insulated switchgear (GIS) - air insulated switchgear (AIS) Substation design.
1 no. Telecommunication Mast for 220kV Substation	36m telecommunication mast/steel lattice tower adjacent to 220kV Substation
220kV Overhead Line	Overhead line (OHL) facilitated by double circuit suspension pylon towers (13 no.) and strain pylon towers (6 No).
220kV Line-Cable Interface Compound	Interface compound to facilitate connection from overhead line to underground connection.
220kV Underground Cable Connection	220kV double circuit Underground Cable (UGC) Connection with paved and gated service road and associated 12no. cable joint bays to facilitate construction and service of underground cables.
400kV Substation	1 no. 400kV GIS loop-in substation adjacent to the existing Oldstreet-Woodland 400kV overhead line. Includes site access off L1010 road.
2 No. 400kV Strain Towers	Strain towers to facilitate connection from the 400kV Substation to the existing Oldstreet-Woodland 400kV overhead line.
1 no. Telecommunication Mast for 400kV Substation	36m telecommunication mast/steel lattice tower adjacent to 400kV Substation
Peat Deposition Area / Soil Deposition Area	Permanent storage of peat and soil from excavations arising during the construction phase of the Electricity Grid Connection. The peat and soil deposition area will not exceed 1m above ground level and will be suitably profiled to eliminate risk of movement or slippage of material.
Tree Replanting Area	A suitably sized area of c. 17 Hectares for tree replanting has been identified and included within

PROPOSED ELEMENT	COMPONENT / DETAILS
	an area of bare cutaway peat, located in the vicinity of the 220kV line-cable interface compound. This area will compensate for all tree felling requirements associated with the Proposed Development.
Temporary Construction Phase Works	The Electricity Grid Connection will include the following Temporary Construction Phase Works: Temporary Contractor compounds and welfare facilities Temporary facilities and stores Temporary construction staff vehicle parking facilities for the duration of the construction phase Temporary security fencing and gates Temporary External lighting Temporary Signage and Traffic Management.

Gas Connection Corridor (part of the Overall Project) - Overview

5.3.6 The Overall Project is anticipated to include the following components in relation to the Gas Connection Corridor (which are presented in detail below in Section 5.6) as per Table 5.3 below:

**Table 5. 3: Gas Connection Corridor (part of the Overall Project) Anticipated/Typical Components (subject to detailed design by GNI)**

PROPOSED ELEMENT	COMPONENT / DETAILS
Gas Connection Corridor	An underground high-pressure (HP) natural gas pipeline (c. 400mm) to transport natural gas from the BGE/77 Transmission Pipeline to the Power Plant Area, Derrygreenagh AGI
	AGI Connection c. 170m setback from L1127 road (north of Rochfortbridge)
	A cathodic protection (CP) system
	Aerial gas pipeline identification marker posts and CP test posts.
Temporary Construction Phase Works	The Gas Connection Corridor element of the Overall Project will likely include the following Temporary Construction Phase Works: <ul style="list-style-type: none"> <li>• Temporary Contractor compounds and welfare facilities</li> <li>• Temporary facilities and stores</li> <li>• Temporary construction staff vehicle parking facilities</li> <li>• Temporary security fencing and gates</li> <li>• Temporary External lighting</li> <li>• Temporary Signage and Traffic Management</li> <li>• Surface water drainage systems including channelling, culverting, crossings and works to existing drainage ditches and systems</li> </ul>



**5.4 Components of the Power Plant Area (part of the Proposed Development)**

5.4.1 The Proposed Development will include the main components in relation to the Power Plant Area (PPA) as per Table 5.1.

Combined Cycle Gas Turbine (CCGT) Plant

5.4.2 The Power Plant Area will include a CCGT Plant configuration at the centre of the power plant area.

5.4.3 The maximum export load will be limited to 570 MW, this will be achieved by the plant being sized to the maximum export load and the plant control system. The process will allow for maximum efficiency of electricity production. The power generation process of the plant is outlined below:

- A gas turbine operating principally from natural gas (or blends) from the gas connection and onsite AGI that will drive a common generator for electricity production.
- Exhaust gases from the gas turbine will pass through a HRSG to generate high-pressure steam.
- The steam generated in the HRSG will drive a steam turbine, which will also drive the common generator to provide additional electrical power (please refer to Plate 5.2 below for illustration of energy generation process from the Power Plant Area).
- In line with the Grid Code the CCGT plant will be capable of operating off a Secondary Fuel (i.e., either HVO or Distillate) in the event of interruption of gas supply to the site and for compliance testing.

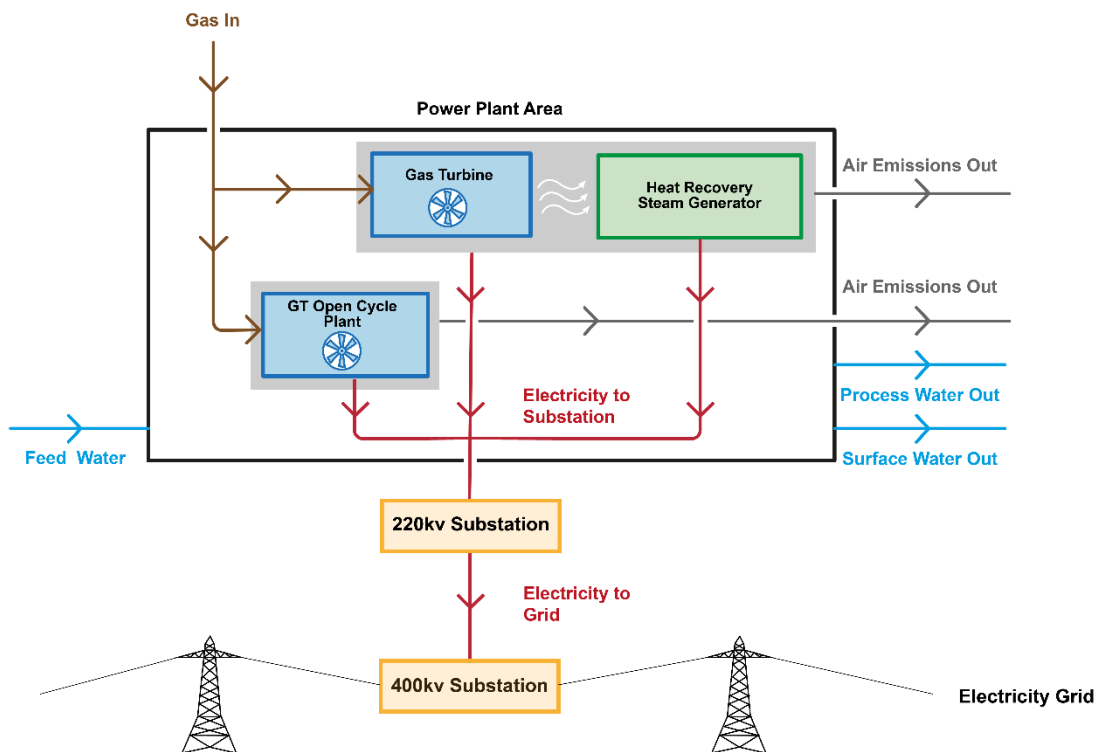

**Plate 5.2: Proposed OCGT/CCGT Schematic Layout**

### CCGT Turbine Hall and Buildings

- 5.4.4 The turbine hall will house the single shaft arrangement of the steam turbine, generator and gas turbine. The hall includes a loading bay/layout area for plant maintenance.
- 5.4.5 The turbine hall also houses most of the shaft line ancillary equipment including the steam turbine/gas turbine lubricating oil system, gland steam system, drains systems, vacuum raising equipment and other auxiliaries. A high-level internal gantry crane will be provided to facilitate maintenance activities in the turbine hall.
- 5.4.6 The proposed building dimensions are 81.1m x 48.4m x 29.9m high.
- 5.4.7 The external cladding will be selected for a recessive colour scheme to blend into the rural/peatland backdrop tones and textures.
- 5.4.8 An electrical annex, to house electrical equipment, will be located to the northwest of the turbine hall. The proposed annex dimensions are 48 m x 17.9 m x 4.5 m. The external cladding of the electrical annex will match the turbine hall.
- 5.4.9 Details and elevations of the proposed CCGT Turbine Hall and buildings are presented on the following figures (refer to EIAR Volume II, Appendix 5C):
- S7060-8050-0004 CCGT Plan
  - S7060-8050-0005 CCGT North & South Elevations
  - S7060-8050-0006 CCGT East & West Elevations

### Heat Recovery Steam Generator (HRSG)

- 5.4.10 The gas turbine exhaust gases are ducted to the HRSG. The HRSG is located directly to the east of the turbine hall. The HRSG contains thousands of finned heat exchanger tubes which generate the steam consumed by the steam turbine. Heat from hot exhaust gases is transferred to water flowing in the HRSG tubes to produce steam. The steam is piped from the HRSG to the steam turbine.
- 5.4.11 To maximise the thermal cycle efficiency, steam is produced at three pressures and is introduced into the steam turbine at three different locations.
- 5.4.12 The principle of reheat is used to further increase thermodynamic efficiency.
- 5.4.13 In reheat the steam exhausting from the HP (high pressure) section of the steam turbine is returned to the HRSG. In the HRSG the steam temperature is increased and then fed to the IP (intermediate pressure) section of the steam turbine.
- 5.4.14 Condensate from the ACC is supplied to the boiler circuits by feedwater pump. The pumps and their auxiliaries are located in a building on the north side of the HRSG.
- 5.4.15 This process reduces the temperature of the exhaust gases down to c. 90°C on exiting the HRSG. The gases are discharged to the atmosphere via an exhaust gas stack located at the outlet of the HRSG.
- 5.4.16 Details and elevations of the proposed HRSG are presented on the following figures (refer to EIAR Volume II, Appendix 5C):
- S7060-8050-0004 CCGT Plan
  - S7060-8050-0005 CCGT North & South Elevations
  - S7060-8050-0006 CCGT East & West Elevations

### CCGT Emissions Stack

- 5.4.17 Detailed air dispersion modelling has been carried out to inform the optimal design of the emissions stack height and the results of this modelling are presented and discussed within Chapter 7: Air Quality and Climate and presented in detail in Appendix 7A in EIAR Volume II.
- 5.4.18 As part of the Power Plant Area, the Combined Cycle Gas Turbine (CCGT) has been specified to comply with the emissions requirements of the Industrial Emissions Directive (IED) without the need for supplemental emissions abatement such as selective catalytic reduction. However, pending detailed design, provision for a selective catalytic reduction system for the CCGT (footprint and ammonia tank) has been made in the design.
- 5.4.19 The cooled exhaust gases for the CCGT will be exhausted by the emissions stack which will be 60m in height (145.25m AOD) and 8.2m in external diameter.
- 5.4.20 The proposed emissions stack for the CCGT will have a metal exterior coloured to blend into the rural/peatland backdrop tones and textures.
- 5.4.21 Water vapour would form part of the composition of the combustion gases released from the proposed emissions stack. Under certain conditions this water vapour contained within stack emissions can cool and condense in close enough proximity to the emission point to form a visible plume.
- 5.4.22 The CCGT stack emissions will be monitored by Continuous Emissions Monitoring System (CEMS). The monitoring system sample points will be located on the stack in line with the EPA guidance. The CEMS may use in situ and extractive instruments. Extractive instruments and the CEMS computer etc will be in a dedicated area at grade level. Emissions from the stack will be monitored continuously and reported in accordance with the requirements for the operation of the Power Plant under an Industrial Emissions (IE) Licence.
- 5.4.23 The CCGT emissions stack will be provided with access ladders and platforms for inspection and maintenance. The platform at the sample points will comply with the EPA guidance (AG1 – Site safety requirements for air emission monitoring).
- 5.4.24 Lighting will be provided on the platforms for maintenance access however the stack will not be permanently lit apart from obstacle lighting as required. If required, aviation lighting will be provided in accordance with a specification agreed with the IAA, and the stack will be lit by steady red obstacle lights at the highest point, visible from all directions.

### Air Cooled Condenser (ACC)

- 5.4.25 An Air-Cooled Condenser will be situated to the northwest of the turbine hall. The ACC will have a maximum length of 80 m, a width of 56 m and a height of 32m.
- 5.4.26 Details and elevations of the proposed ACC are presented on the following figures (refer to EIAR Volume II, Appendix 5C):
- S7060-8050-0001 ACC Plan
  - S7060-8050-0002 ACC Elevations
  - S7060-8050-0003 ACC Section
- 5.4.27 Steam exhausting from the steam turbine is ducted to the ACC. The ACC consists of a large array of finned tubes with a set of fans located beneath them. Air is forced through the finned condenser tubes by multiple variable speed drive forced draught fans. Heat is transferred from the steam to the air condensing the steam.

- 5.4.28 The condensate is collected in a tank under the ACC and then pumped over to the boiler feedwater pump building to supply the feedwater pumps.
- 5.4.29 The proposed air-cooled condenser will have the condenser tube arranged to form a series of “A” frames. These are typically referred to as streets. It is anticipated that the ACC will consist of 5 streets. Each street is provided with a set of fans.
- 5.4.30 In areas where there is not an available supply of cooling water, such as around the Derrygreenagh site, ACC’s are the preferred cooling option for power plants. They also have the benefit of not giving rise to visible water vapour plumes, unlike wet and hybrid cooling towers.

Air Intake (CCGT)

- 5.4.31 The northern facade of the turbine hall will include the gas turbine air intake. The proposed air intake will have face dimensions up to 20m in height and 18m in width and will protrude 16m from the northern façade of the turbine hall.
- 5.4.32 The gas turbine located in the Turbine Hall requires large volumes of filtered air during operation. Filtration of the air is vital for the efficient and reliable operation of the gas turbine. The air intake structure will draw in air from outside of the turbine hall via louvres. The louvres minimise the amount of rain drawn in with the air and the noise emission out of the intake. The air will pass through up to three layers of filtration during operation to remove entrained particles. As the filters become loaded with entrained particles, they will require periodic cleaning or replacement. This will be completed when the gas turbine is offline.
- 5.4.33 During cold weather the air intake and internals are prone to icing up which reduces air flow through the intake and consequently the power output of the gas turbine. To mitigate ice build-up the air intake will incorporate a de-icing system. The system will use induction elements or hot air to prevent ice build-up. This system will only operate when the gas turbine is running and there is low ambient air temperature.
- 5.4.34 Details and elevations of the proposed CCGT Air Intake are presented on the following figures (refer to EIAR Volume II, Appendix 5C):
- S7060-8050-0004 CCGT Plan
  - S7060-8050-0005 CCGT North & South Elevations
  - S7060-8050-0006 CCGT East & West Elevations Open Cycle Gas Turbine (OCGT) Plant
- 5.4.35 The Power Plant Area will include OCGT Plant comprising of two gas turbines, generators and associated ancillaries located in the southwestern section of the site. The generators and gas turbines will be modular units housed in weatherproof enclosures. The associated ancillaries will be located in a number of weatherproof enclosures located around the gas turbines and generators. The OCGT plant will occupy an area of approximately 6,000m<sup>2</sup> (0.6 Ha). Except for the stack and the air intakes the OCGT plant structures will generally be under 6m in height.
- 5.4.36 The energy output of the OCGT will be limited to c. 140 MW. This will be achieved by the Plant being designed, installed and controlled to deliver the specific energy output that is proposed (i.e., c. 140 MW). This is an essential part of maximising the efficiency and performance of the Plant.
- 5.4.37 The gas turbines and ancillary plant elements (gas and secondary fuel skids etc.) will have a containerised control module(s) which will house the control system and a containerised electrical module(s) which will supply power to the gas turbine(s) and

associated auxiliary systems. A transformer will step up the generated voltage to 220kV to allow power to be exported to the 220kV electrical substation.

- 5.4.38 A forced air auxiliary cooling system will transfer heat from the lubrication oil and other ancillary systems to the atmosphere.
- 5.4.39 Operating in open cycle configuration allows the turbine(s) to respond with full power output within 20 minutes of being instructed to do so. This fast response allows the turbine to provide rapid essential balancing services to the grid from a standby state.
- 5.4.40 The gas turbine(s) will fire primarily natural gas to generate power. In compliance with the grid code, they can operate on a secondary fuel. This will either be distillate or HVO. Operation using secondary fuel is only in the exceptional event of a loss of pressure in the gas transmission system and other generation sources on the transmission grid cannot meet demand. Secondary fuel will also be used during fuel security compliance tests (to confirm the readiness of the turbine(s) to respond to a call to fire on distillate fuel in the event of an emergency).
- 5.4.41 The Open Cycle Gas Turbine (OCGT) Plant has been specified to comply with the emissions requirements of the Industrial Emissions Directive (IED) without supplemental emissions abatement such as selective catalytic reduction. Consequently, the flue gases generated will pass directly from the gas turbine(s) to a flue stack structure. Air Intake (OCGT Plant).
- 5.4.42 As with the CCGT, a OCGT requires large volumes of filtered air during operation for the efficient and reliable operation. OCGT air intakes are functionally identical to and incorporate the same features as CCGT air intakes.
- 5.4.43 The configuration of a OCGT air intake is manufacturer dependent. Generally, they are a single face design similar to that of the CCGT and are mounted above the gas turbine and or generator module.
- 5.4.44 Details and elevations of a typical OCGT Air Intake are presented on the following figures (refer to EIAR Volume II, Appendix 5C):
- S7060-8050-0012 OCGT Plan
  - S7060-8050-0013 OCGT West & East elevations
  - S7060-8050-0014 OCGT North & South elevations
  - S7060-8050-0015 Section Through OCGT

Emissions Stack (OCGT Plant)

- 5.4.45 The Open Cycle Gas Turbine (OCGT) plant has been specified to comply with the emissions requirements of the CID (EU) 2021/2326 establishing best available techniques (BAT) for Large Combustion Plant (LCP) Industrial Emissions Directive (IED) without supplemental emissions abatement such as selective catalytic reduction.
- 5.4.46 Consequently, the flue gases generated will pass directly from the gas turbines to a single dedicated flue stack structure. The stack structure will contain 2 flue gas ducts.
- 5.4.47 The OCGT plant will be fired primarily on natural gas however it also has the functionality to fire on locally stored secondary fuel in the exceptional event of a loss of pressure in the gas transmission system. This back-up fuel will be distillate or HVO.
- 5.4.48 The proposed flue gas ducts will be 45m high (at 130.25m AOD) and 3.64m in diameter (3.54m internal width). Detailed air dispersion modelling has been carried out to inform the stack height and is discussed within Chapter 7: Air Quality and presented in detail in

Appendix 7A in EIAR Volume II. Details and elevations of the proposed emissions stack are presented on the following figures (refer to EIAR Volume II, Appendix 5C):

- S7060-8050-0012 OCGT Plan
- S7060-8050-0013 OCGT West & East elevations
- S7060-8050-0014 OCGT North & South elevations
- S7060-8050-0015 Section Through OCGT

5.4.49 A combination of the high exhaust gas temperature, low NO<sub>x</sub> content, and absence of visible combustion particulates mean that the proposed OCGT plant will not form a visible plume. The exhaust temperature is such that water vapour in the flue gas is unlikely to condense close to the stack structure before dispersal, even during times of very low ambient temperature. The OCGT is compliant with current best available techniques for NO<sub>x</sub> limits and the characteristic yellow tint to the flue gases from the presence of high levels of NO<sub>x</sub> will not be visible.

5.4.50 Emissions from the stack will be monitored and reported in accordance with the requirements for the operation of the Power Plant Area under an Industrial Emissions (IE) Licence.

#### Secondary Fuel Storage and Unloading Facility

5.4.51 The facility is required under the Grid Code Secondary Fuel Obligations to maintain a secondary fuel supply. The obligation requires the storage of sufficient secondary fuel for 5 days operation of the CCGT plant and 3 days of the OCGT plant. The CCGT and OCGT plants operate on the same secondary fuel.

5.4.52 The fuel will be contained in 2 No tanks within a bunded area to the south of the site (east of the OCGT Plant).

5.4.53 A fuel forwarding pump set will forward the secondary fuel from the storage area to the plants when required. A gantry will carry the fuel forwarding and return lines to the CCGT and OCGT plants.

5.4.54 The Secondary Fuel will only be used in the unlikely event that both the gas connection is unavailable and other generation sources on the transmission grid cannot meet demand.

5.4.55 The secondary fuel storage facility and associated equipment will have a footprint of approximately 3,200m<sup>2</sup>.

#### *Fuel Offloading*

5.4.56 The secondary fuel will be received via road tanker. A dedicated unloading layby is provided. This area will include a drainage system which will link into the power station drainage system with interceptors and containment to capture any potential oil spills.

#### *Fuel Storage Tanks*

5.4.57 Fuel will be stored in 2 no. 8,350 m<sup>3</sup> gross capacity site fabricated steel storage tanks (each with a diameter of 22m and shell height of 22m).

5.4.58 Bunding and associated pipework will be designed in accordance with EPA Guidance Note on Storage and Transfer of Materials for Scheduled Activities. The secondary containment (bund) design will allow the greater of 110% of the largest tank within the bund or 25% of the total volume of substance within the bund, whichever is the larger.

5.4.59 The site drainage system design provides tertiary containment for oil contaminated water should the bund overflow, e.g., as a result of a major tank fire.



- 5.4.60 The quantity of secondary fuel to be stored on site qualifies as lower tier Seveso III as designated under Council Directive 2012/18/EU transposed in Ireland by the Chemicals Act (Control of Major Accident Hazards Involving Dangerous Substances) Regulations 2015 (COMAH Regulations). The Health & Safety Authority (HSA) will be notified prior to commencing construction of the facility and a Major Accident Prevention Policy (MAPP) will be prepared and reviewed prior to commencement of operation of the facility. Refer to EIAR Volume II Appendix 18B Major Accident to the Environment (MATTE) assessment.

*Fuel Forwarding Building*

- 5.4.61 A fuel forwarding building is located at the east side of the fuel oil storage tank secondary containment. The building contains the fuel oil transfer pumps and fuel conditioning equipment. The pumps provide secondary fuel to the CCGT and OCGT fuel modules when the gas turbines are operating on secondary fuel. The proposed building dimensions are 19 m x 9.9 m x 5.9 m (refer to EIAR Volume II, Appendix 5C, S7060-8050-0018 and 0019).

*Secondary Fuel Gantry*

- 5.4.62 A gantry will carry the fuel forwarding and return lines to the CCGT or OCGT from the secondary fuel storage and will comprise of ground level and, over roads etc, elevated sections. The elevated sections will be supported by 5m tall frames. Route width will be approximately 1m. Total route length will be approximately 250m (refer to EIAR Volume II, Appendix 5C, S7060-8050-0034 for typical elevated section).

- 5.4.63 The overhead gantry is sufficiently high over roadways as not to impede vehicle access within the site. The frame will be fabricated from carbon steel with either a galvanised or painted corrosion protection coating.

Subsidiary items of plant/equipment (on Power Plant Area)

*Propane Ignition System*

- 5.4.64 The gas turbines include the functionality to fire on locally stored secondary fuel during emergencies. The gas turbines cannot start directly on secondary fuel however and propane gas is required to aid start-up.
- 5.4.65 The quantity of propane required compared to the normal fuel consumption of the gas turbines is relatively small. Propane will be stored in 2 no c.1 tonne Propane Tanks (2 m<sup>3</sup> tanks), with one tank to be located to the North of the CCGT and the other located to the East of the OCGT. (refer to EIAR Volume II, Appendix 5C, Figure Ref: S7060-8050-0033).

*Secondary cooling system fin/fan coolers*

- 5.4.66 The CCGT and OCGT plants are provided with secondary cooling systems for ancillary systems, e.g., the lubrication oil systems. The systems transfer heat to the atmosphere via fin/fan coolers. The coolers are located to the north of the HRSG for the CCGT and adjacent to the OCGT plant. The CCGT cooler will be approximately 34m long, 19 wide and 8m high. The OCGT coolers will be similar in arrangement but smaller (refer to EIAR Volume II, Appendix 5C, Figure Ref: S7060-8050-0035).

*Emergency Diesel Generator*

- 5.4.67 An emergency diesel generator (EDG) is provided to allow safe 'power down' of the gas & steam turbines and essential auxiliaries in the event of loss of grid supply to the site (refer to EIAR Volume II, Appendix 5C, Figure Ref: S7060-8050-0040).
- 5.4.68 The EDG will be located in the northeast of the power plant area, to the west of the auxiliary fin fanned coolers. The EDG will be housed within a pre-fabricated container (12m x 3.5m and 3.5m high). It will contain a small integral bunded diesel tank and will be for limited and emergency use only (i.e. 15 mins testing per month and 4 hours run time in the event it is required; due to limited use the EDG is therefore scoped out of formal noise assessment and air quality assessment in the EIAR).

*Firefighting systems*

- 5.4.69 Fire detection and protection systems will be provided to ensure early detection of any fires within the facility and provide the means for firefighting in the event of fire being detected. The fire risks will be assessed during the detailed design stage in line with the Fire Services Acts 1981 and 2003 and the published code of practice. The general design of the active and passive fire protection measures will be designed in accordance with NFPA 850 Recommended Practice for Fire Protection for Electric Generating Plants and High Voltage Direct Current Converter Stations. The fire detection and alarms system shall generally be in accordance with IS 3218. A dedicated supply of firewater will be maintained on the site. A central fire alarm panel will be installed in the control room to alert the operators in the event of fire.
- 5.4.70 The CCGT and OCGT are installed in ventilated and acoustical insulated enclosures. The enclosures incorporate fire and gas detection systems. The gas turbines and fuel systems are automatically shutdown in the event of a fire or a gas leak. The enclosures are provided with an automatic fire suppression system.

*Raw and Fire Water storage*

- 5.4.71 Ground water will be abstracted from the aquifer underlying the site via duty and standby boreholes. The abstracted water will be stored in a raw water tank. The tank provides a buffer volume to cover potential fluctuations or short interruptions in the raw water supply. The raw water will be treated to provide potable and demineralised water for the site. Fire water will be stored in a reserved section of the raw water tank. The raw water tank is a 7,850 m<sup>3</sup> gross capacity site fabricated steel storage tank (with a diameter of 25m and height of 16m).

*Demineralised water storage*

- 5.4.72 The Power Plant Area will have 2 no. 7,850 m<sup>3</sup> gross capacity demineralised water storage tanks (with a diameter of 25m and height of 16m). These tanks provide a demineralised water reserve for both the CCGT and OCGT plants. The reserve is provided to cover supply interruptions due to failures in the raw water supply or the demineralised water production plant. The tanks provide a reserve for water injection to the gas turbines, if required, during secondary fuel operations. Sufficient water is provided to cover the operation of the plant on the secondary fuel reserve in the site fuel tanks.



---

*Generator and Auxiliary Transformers*

- 5.4.73 Power generated will be stepped up from the generator voltage to 220kV by a pair of generator transformers for export via the new 220kV substation site located on the western side of the R400 road.
- 5.4.74 The CCGT generator transformer is to the north of the CCGT turbine hall. The OCGT generator transformer is to the north of the OCGT stack (refer to EIAR Volume II, Appendix 5C, Figure Ref: S7060-8050-0040 for the locations and Figure Ref: S7060-8050-0035 for a typical arrangement).
- 5.4.75 The OCGT and Generator transformers are located in transformer bays enclosed on three sides by concrete walls and on the 4<sup>th</sup> side by a fence. The transformer bays are similar in configuration but are different in size. In general, the transformer bays will contain of the following:
- Generator transformer and oil cooling system;
  - 220kV Disconnectors (DISC) also known as Isolators;
  - 220kV Earth Switches (E/SW);
  - 220kV Cable Sealing Ends (CSE);
  - 220kV Protection and Metering Current Transformers (CT);
  - 220kV Protection and Metering Voltage Transformers (VT); and
  - Protection and Control linked into the power plant monitoring and control system.
- 5.4.76 As the generator transformers contain oil the bay forms a bund capable of retaining 110% of the transformer oil capacity. The site drainage system design provides tertiary containment for oil contaminated water should the bund overflow e.g. as a result of a transformer fire.
- 5.4.77 The power requirements of the project will be taken from the export power connections and will be stepped down for local usage via auxiliary transformers. The auxiliary transformers are significantly smaller than generator transformers (typically 1% or less of the design rating).

*Silencers, vents, drains and safety valves*

- 5.4.78 The HRSG which generates the steam from the gas turbine exhaust gases requires vents, drains and safety valves to support plant start-up, shutdown and normal operation. To mitigate against excessive noise during start-up and warming of the HRSG and operation of the safety valves, silencers are installed at the top of the HRSG structure.

*Underground/Overground Services (gas and heat export pipework and electrical cabling)*

- 5.4.79 As part of the Proposed Development a three phase 220kV high voltage cable system will be installed between each of the generator transformers and the 220kV substation located on the western side of the R400 road. The cable system will generally consist of 3 individual cables, one for each phase. These cables will be buried and pass under the road via the existing light railway underpass bridge (refer to EIAR Volume II, Appendix 5C, Figure Ref: S7060-8050-0040).
- 5.4.80 The development will connect to the national natural gas distribution system at the Gas Networks Ireland Derrygreenagh AGI.
- 5.4.81 The AGI is located northwest of the power plant area adjacent to the R400 road. The compound will be c. 85m x 85m (refer to EIAR Volume II, Appendix 5C, Figure Ref:

S7060-8050-0009, 0010 and 0011). The compound is surrounded by a 2.4m high fence and will contain:

- provision for a temporary pig receiver
- gas filters
- gas meters and metering system housing
- pressure reduction stations
- dew point heater and associated boiler enclosures
- welfare kiosk
- control and communications systems and kiosks

5.4.82 From the AGI gas will be routed to the OCGT plant fuel skid(s) via a buried pipe.

5.4.83 For the CCGT gas will be routed from the AGI to the Gas Receiving Facility (GRF) at the north of the Site via a buried line.

5.4.84 The Gas Receiving Facility is provided to ensure that the natural gas is supplied at the correct pressure to the CCGT plant (refer to EIAR Volume II, Appendix 5C, Figure Ref: S7060-8050-0030). The GRF is in a compound. The compound will be c. 95m x 38m and will contain:

- gas compressor(s) in a building
- fin/fan coolers for the compressor(s)
- pressure reduction stations
- dew point heater and associated boiler enclosures

5.4.85 From the GRF gas will be routed to the CCGT plant via a buried pipe.

5.4.86 Steam will be routed from and to the CCGT HRSG by insulated pipework. The pipework will be routed above ground generally within the HRSG enclosure and the turbine hall.

5.4.87 Power supplies are distributed throughout the Power Plant Area from the electrical switchgear rooms and enclosures. The Power Plant Area system are connected to the plant control system (DCS) via control cables.

5.4.88 The power and control cables will run on cable tray, ladder racks or ducts. Outdoors the ducts will be buried.

#### *Landscape Mitigation*

5.4.89 Embedded mitigation measures form an integral part of the Proposed Development design. The Proposed Development has been designed, as far as practicable, to avoid adverse effects on the landscape character and visual amenity through consideration of options, appraisal, and refinement. Modifications made to the design of the Proposed Development to avoid and reduce effects include mainly limiting the extent of land-take, siting of components, and, where possible, minimise impacts on established vegetation and features that contribute to landscape character and visual amenity.

5.4.90 In addition, the proposed colour scheme of the building facades forms part of the embedded landscape mitigation with the primary objective to minimise the visual impact of the built structures and to allow the buildings to be as unobtrusive as feasible against their backdrop. The proposed colour scheme will range within a muted mid-dark grey and green spectrum and was drawn from colours found the surrounding local landscape. The indicative colour scheme has been illustrated in the photomontages included in EIAR

Volume II, Appendix 10A. The final colours of the buildings will be agreed with Offaly County Council prior to commencement of construction.

Associated buildings and infrastructure

- 5.4.91 A number of buildings within the existing Derrygreenagh Works will require demolition as part of the Proposed Development to facilitate construction of the Power Plant Area (refer to Section 5.4.128 below and CEMP (Appendix 5A) for more detail on demolition works). These existing buildings include offices, workshops and associated buildings which will be demolished and replaced with new offices, workshop and ancillary units designed to serve the Power Plant Area. Please refer to Figure S7060-8050-0054 for location of these buildings in relation to Power Plant Area.
- 5.4.92 Access to the Power Plant Area site and the Derrygreenagh AGI will be from the R400 via a new access point to the north of the existing entrance. This will be the access point for construction and operational traffic.
- 5.4.93 Perimeter fencing, gates, CCTV, internal fencing, access control systems, lighting and other measures will be installed within the site for health and safety as well as site security purposes. The perimeter fence will be 2.4m high.
- 5.4.94 A car park for the operational phase of the Power Plant Area is to be located to the south of the site access road with the administration building to the east. The car park will provide 62 no. car parking spaces for the use of the station staff, visitors and a limited number of contractors. There will be a minimum of 4 No accessible parking spaces located closest to building entrance. There is provision for several electric vehicle charge points in the car park. Surface water from the carpark is discharged to the site surface water drainage system via a bypass oil interceptor.
- 5.4.95 The administration building is located on the east side of the carpark. The building will have an external footprint of approximately 1,350m<sup>2</sup> and will be 10.6 m to the roof apex. The building will include offices, open plan seating areas, toilets, changing rooms, shower facilities, a main control room (MCR), canteen, boardroom and smaller meeting rooms (refer to EIAR Volume II, Appendix 5C, Figure Ref: S7060-8050-0007 and 0008).
- 5.4.96 The building has been designed to meet all building regulations requirements in accordance with technical guidance documents produced for compliance with regulations<sup>1</sup>.
- 5.4.97 The Power Plant is operated from the main control room (MCR), where it will be possible to monitor and control the complete Power Plant, including emission points. Appropriate computer screens, indications and alarms are provided to allow the plant operators to monitor and adjust the plant systems and equipment or stop discharges where operations are at risk of breaching ELVs.
- 5.4.98 Segregated pedestrian access will be provided from the car park to the administration building and throughout the Power Plant Area.
- 5.4.99 All roads through/within the Power Plant Area will be hard surfaced. Surface water from the roads is directed to the site surface water drainage system via a bypass oil interceptor.

---

<sup>1</sup>Building Control Regulations 1997 as amended.  
Technical Guidance Documents A-K  
gov.ie - Technical Guidance Documents ([www.gov.ie](http://www.gov.ie))

*Workshop, Stores, lubrication oil storage building*

- 5.4.100 The workshop and stores, which are a combined building (footprint 1,550m<sup>2</sup>, height to apex 14.2m), and the lubrication oil storage building (footprint 115m<sup>2</sup>, height to apex 8.7m) are located in sequence between the CCGT and OCGT plants in the middle of the site (refer to EIAR Volume II, Appendix 5C, Figure Ref: S7060-8050-0016, 0017, 0020 and 0021). The external finish of the workshop and stores and oil storage building will comply with the agreed scheme for the overall site. The workshop, stores and oil storage building are designed to support the Power Plant maintenance tasks.
- 5.4.101 The workshop internal layout will include an office, welfare facilities, laydown, general and dedicated workshops, consumable storage areas, cabinets etc. The workshop may contain a mezzanine level over part of the floor area.
- 5.4.102 The Stores will have 2 No levels, a ground floor and mezzanine floor level. The stores internal layout will include an office, racking system, bins, cabinets etc for the spares required by the Power Station.
- 5.4.103 The lubrication oil storage building will contain the bulk lubrication and other oils required for the maintenance of the Power Plant. The building internal layout includes provision for the storage of drums, IBC's etc. The oil storage building design incorporates a bund to retain any oil spillage within the building.
- 5.4.104 Spill kits will be provided at appropriate locations throughout the plant where hazardous materials will be stored and used.

*Water Treatment Plant*

- 5.4.105 Raw water will be treated in the water treatment plant to produce the potable and demineralised water required for the Power Plant. The water treatment plant is located on the east side of the plant adjacent to the raw and demineralised water tanks (refer to EIAR Volume II, Appendix 5C, Figure Ref: S7060-8050-0024).
- 5.4.106 The water treatment process will consist of filtration, and either a resin based or a reverse osmosis-based treatment system. A resin-based system will utilise an acid and an alkali for resin regeneration. If a softening plant is required for pre-treatment this will utilise a brine solution for regeneration. These chemicals will be delivered by road tanker and stored on site in banded storage tanks.

*Steam and water circuit*

- 5.4.107 The feedwater used in the HRSG will be thermally de-aerated to remove oxygen and chemically treated to prevent corrosion of the tubes and components of the water/steam cycle. A range of specialist chemical treatment options are available for boiler feedwater. The baseline dosing chemicals for the steam and water circuits are Ammonia (NH<sub>3</sub>) and Tri Sodium Phosphate (Na<sub>3</sub>PO<sub>4</sub>).
- 5.4.108 The dosing system includes banded tanks and dosing pumps and will be located within the HRSG or boiler feedwater pump areas.

*Process Water Treatment Plant*

- 5.4.109 The process wastewater to be discharged from the site comprises primarily of effluent from the water treatment plant and from boiler blow-down.
- 5.4.110 Wastewater from the water treatment plant comprises of an aqueous solution containing all the solids and minerals of the raw water. The volumes of effluent generated depend on the demineralisation process used. Reverse Osmosis based processes produce a higher volume of wastewater than a resin-based demineralisation process. With both technologies the total amount of solids and minerals in the wastewater is the same,

therefore the concentration per unit volume of wastewater is lower with RO and higher with resin-based plants. The wastewater from the water treatment plant is discharged to the process water treatment plant.

- 5.4.111 The demineralised water contains residual amounts of non-volatile impurities. These impurities build up in the drums of the HRSG of the CCGT plant. Build-up of the impurities will lead to corrosion and other issues within the steam and water circuit. To maintain the impurity the HRSG drums are “blown down”. This is a continuous operation when the CCGT plant is in operation. Generally, the blowdown flow comprises up to 1% of the flow circulation in the steam and water circuit. A proportion of the blowdown water is flashed to steam and is either recovered into the steam and water cycle and/or discharged to the atmosphere. The losses from the circuit due to blowdown, other losses etc is made-up with demineralised water.
- 5.4.112 The hot blowdown is cooled before being discharged to the process water treatment plant.
- 5.4.113 All process wastewater arising from the facility will be collected in the process wastewater tank prior to discharge. The tank will be an open topped below ground concrete structure. Monitoring and treatment system will be located at ground level adjacent to the tank.
- 5.4.114 The process wastewater tank provides a buffer volume to allow the plant to operate for a period when discharge to the consented discharge point on the Yellow river is not possible. The process wastewater tank is provided with a monitoring and treatment system. The wastewater is pumped from the tank to the discharge point via a pipeline. The discharge pipe is provided with pH, temperature and flow measurements, sampling and injection points and a recirculation loop. Discharge only takes place if the quality of the wastewater is within the Emission Limit Values (ELVs) for the consented discharge point. When not discharging or if the wastewater lies outside of any of the ELVs for the consented discharge point, the wastewater is recirculated back to the process wastewater tank. The wastewater is dosed automatically, if required, to regulate the pH etc within the ELV limits.
- 5.4.115 The process wastewater tank will be sized to allow 24 hours of plant operation without discharge to the Yellow river. It is anticipated that the working volume of the tank will be approximately 500m<sup>3</sup>.

#### *Foul Water Treatment Plant*

- 5.4.116 An assessment of the existing site percolation area has been undertaken for inclusion in the ‘Site Characterisation Form’ submitted with the application. It is determined that the existing drainage and subsoil percolation rates have insufficient capacity to manage the proposed discharge rates from the whole site foul water load of approximately 6 m<sup>3</sup> day based on 100 l/d/person of effluent and 60 people.
- 5.4.117 Foul water will therefore be treated in a packaged treatment plant and then discharged to the process wastewater plant and then to the consented discharge point on the Yellow river.

#### *Surface water drainage and attenuation*

- 5.4.118 A flood risk and drainage assessment is presented in EIAR Appendix 12.A (refer to EIAR Volume II).
- 5.4.119 Surface water runoff will be generated from all hard-finished surfaces within the power plant site which are exposed to rainwater or to which water is applied for wash down etc. This includes all hardstanding surfaces, roofs, and other impermeable surfaces.



- 5.4.120 Approximately 1.1ha of the site is expected to drain to the proposed surface water system, while 1.8ha of the site will permeate to ground naturally.
- 5.4.121 The drainage systems are designed in accordance with the Sustainable Urban Drainage System (SUDs) guidance and EN 752 and EN 12056.
- 5.4.122 All surface water arising from hardstanding areas within the power plant site will be collected in an open topped below ground concrete attenuation tank. The attenuation tank working volume will be approximately 6,600 m<sup>3</sup>. Power Plant Area
- 5.4.123 All surface water runoff will be discharged to the attenuation tank via a hydrocarbon interceptor and silt trap. Water from roof drains may discharge directly to the attenuation tank. Water in the attenuation tank will be pumped to the consented discharge point on the Mongagh River. The discharge flow is monitored and controlled to maintain the rate within the limits specified in the permit.
- 5.4.124 Discharge to the Mongagh River can be stopped by the plant operators both locally and remotely in the event that there is an event that could lead to the discharge from the attenuation tank breaching the ELVs e.g. a fire.

*Firewater Retention*

- 5.4.125 The Power Plant Area process and surface water drainage systems are designed to retain firewater within the site system until it can be treated and discharged or disposed of offsite.

*External lighting*

- 5.4.126 The operational phase external lighting scheme will be designed to provide safe working conditions for the development whilst reducing light pollution and the visual impact on the local environment. The lighting system will comply with the guidance provided by HSG38 Lighting at Work, the Society of Light and Lighting guides and EN 12464-2

*Utilities*

- 5.4.127 In general, the development will provide its own utility services. The exception will be telecommunications services which will be provided by an external party.

*Demolition Works*

- 5.4.128 Demolition of a number of buildings and structures within the existing Derrygreenagh Works is included as part of the Proposed Development in relation to the Power Plant Area. While the effects of the demolition will be permanent, the demolition works activity themselves will be temporary and related to site preparation in advance of construction works.
- 5.4.129 The buildings and structures to be demolished on the Power Plant Area include:
- Site Offices;
  - Boiler House;
  - Workshop #1;
  - Workshop #2;
  - Water Tank; and
  - Storage Unit.
- 5.4.130 Ahead of the dismantling and demolition works surveys/inspections will be undertaken to determine if there are any hazardous materials etc present. The reports from these surveys/inspections will be made available to the demolition contractors.

5.4.131 Asbestos will be progressively removed throughout the works in full compliance with current regulations. The removal of all hazardous materials is to be carried out prior to demolition work commencing and disposed of in line with the relevant legislation. The coating on the external sheeting is known to contain some asbestos bearing material.

5.4.132 The proposed demolition process will be undertaken in the following general stages:

- Removal of re-usable plant;
- Progressive stripping and disposal of asbestos (if present);
- Stripping out of internal equipment and fittings for scrap;
- Breaking up of the internal concrete floors;
- Demolition of external components and structures.

5.4.133 The demolition works will include a number of different methodologies and it is anticipated that a combination of the following demolition methods will be used for the proposed demolition works:

- Manual removal of asbestos and asbestos containing materials (if / where required);
- Dismantling (reverse installation);
- High Reach Demolition Plant;
- Hot Works (cutting) to enable dismantling;
- Cranage ;
- Vibration Pecker to break out concrete into smaller manageable sections;
- Manual gas/plasma cutting - cutting electrically conductive materials like mild steel, stainless steel, copper, aluminium.
- Hydraulic shears / crushers – used to demolish reinforced concrete and other materials.

5.4.134 Plant and equipment will be typical of a project of this scale and typically include heavy duty earthmoving plant, excavating equipment. Vehicles and equipment will be securely stored within the Power Plant Area.

5.4.135 Table 5.4 details the quantity of demolition wastes to be generated through the removal of the existing buildings.

**Table 5. 4: Demolition Quantities**

<b>DEMOLITION QUANTITIES</b>	<b>MATERIAL QUANTITY</b>
Strip Concrete volume	375m <sup>3</sup>
Floor slab concrete volume	1,650m <sup>3</sup>
Masonry volume	800m <sup>3</sup>
Cladding area	6,475m <sup>2</sup>
Asbestos containing cladding	2,400m <sup>2</sup>

5.4.136 Given the nature of the Proposed Development and the volume of wastes that will be generated, wastes will be classified, segregated, stockpiled, recycled and disposed of from the site to appropriately licensed receiving facilities.

5.4.137 Having regard to the provisions of “A Waste Action Plan for a Circular Economy – Ireland’s National Waste Policy 2020–2025”, and the “Best Practice Guidelines for the Preparation of Resource and Waste Management Plans for Construction and Demolition Waste Projects”, a Resource Waste Management Plan (RWMP) will be prepared by the appointed contractor prior to work commencing to help manage site waste more effectively, reducing potential harm to the environment and human health.

5.4.138 The demolition works will take place prior to the main construction works and will take approximately 6 months.

#### Peat and Soil Deposition Area

5.4.139 A permanent Peat Deposition Area (PDA) is provided in the vicinity the Power Plant Area to store excess overburden material which cannot be used in localised landscaping or backfill. Excavated peat and soil arising from the formation of the foundations will be placed in a designed and dedicated deposition area in close proximity on land to the east of the Power Plant Area (refer to EIAR Volume II, Appendix 5C, Figure Ref: S7060-8050-0055).

5.4.140 It is estimated that approximately 153,000 m<sup>3</sup> of excess peat and soil will be required to be stored within the permanent PDA.

5.4.141 Peat will be deposited to a maximum height of 1m above ground level across an area of approximately 225,000m<sup>2</sup>. Once excavations are completed and following the commissioning of the project, the PDA will be allowed to naturally revegetate.

#### Construction Phase Works

5.4.142 The following temporary infrastructure will be required for the construction phase of the Power Plant Area. In general, temporary infrastructure will be removed at the end of the construction phase of the project.

#### *Construction Contractor compounds and welfare facilities*

5.4.143 The areas allocated for the Power Plant construction contractor compounds are on the west and north sides of the of the Power Plant Area. These areas will be used for the unloading and storage of construction materials, temporary site offices and welfare facilities, and construction staff vehicle parking (refer to EIAR Volume II, Appendix 5C, Figure Ref: S7060-8050-0040). Some pre- fabrication of materials and components will also be undertaken in these areas.

5.4.144 The EPC contractor will carry out all works associated with preparing the areas for use and installing all required services. The arrangement of the contractor compounds will evolve over the duration of the project. Detailed requirements and designs will therefore be developed during the detailed design phase by the EPC contractor.

5.4.145 Wastewater from welfare facilities will be directed to a sealed storage tank, with all wastewater tankered off site by an appropriately consented waste collector to a licensed disposal plant.

5.4.146 All construction chemicals, oil and grease etc. will be stored in appropriate containers, cabinets and bunded areas.

5.4.147 Construction vehicles and equipment will be parked on hard standing and/or provided with drip trays as appropriate.



*Surface water drainage*

- 5.4.148 The construction compounds will consist of a mixture of permeable, semi-permeable and hardstanding areas.
- 5.4.149 The construction compounds will be provided with drainage systems designed in accordance with EN 12056 and provided with silt traps and, if required, hydrocarbon interceptors. The surface water will infiltrate into the ground and/or be discharged into the local area drainage system. A detailed drainage plan for the construction phase will be developed during the detailed design phase by the EPC contractor.
- 5.4.150 Access to the construction compounds for staff, plant and deliveries will be via the Power Plant Area entrance (east off the R400 road). Construction traffic volumes have been assessed against Transport Infrastructure Ireland (TII) guidance (please refer to Chapter 14: Traffic, for more detail).

*Construction security*

- 5.4.151 Construction security is the responsibility of the EPC Contractor. Temporary perimeter fencing, gates and access control measures will be provided for the Power Station Site. There will also be additional security fencing around the construction compounds and specific areas of the site for access control, safety and security. The temporary perimeter fencing, gates and access control measures will be replaced by the permanent installations.

*Construction lighting*

- 5.4.152 The construction phase lighting scheme will be developed by the EPC contractor and designed to provide safe working conditions for the development whilst reducing light pollution and the visual impact on the local environment. The lighting system will comply with the guidance provided by HSG38 Lighting at Work, the Society of Light and Lighting guides and EN 12464-2.

*Temporary Signage and Traffic Management*

- 5.4.153 Temporary Signage will be provided for the construction site as required by legislation.
- 5.4.154 Signage at site entrances will be provided providing outline details of the project. These signs shall have a Project contact telephone number for the general public.
- 5.4.155 All traffic management measures will comply with those outlined in the accompanying Construction Traffic Management Plan (Refer to Appendix 14H, EIAR Volume II) submitted as part of this planning application. The Construction Traffic Management Plan will remain a live working document and will be finalised by the EPC contractor, in consultation with Offaly and Westmeath County Councils, prior to the commencement of development.
- 5.4.156 Traffic management and road signage will be in accordance with the Department of Transport: Traffic Signs Manual - Chapter 8: Temporary Traffic Measures and Signs for Road Works and in agreement with Offaly and Westmeath County Councils. All work on public roads will be subject to the approval of a road opening license application.

## **5.5 Components of the Electricity Grid Connection (part of the Proposed Development)**

5.5.1 The Proposed Development will include the main components in relation to the Electricity Grid Connection (EGC) as per Table 5.1.

### 220kV Substation

5.5.2 It is proposed to construct a 220kV electricity substation west of the R400 road (refer to EIAR Volume II, Appendix 5C, Figure Ref: BNM-DPS-E-2000 & E-2001). Access to the substation will be west off the R400 road. Upon decommissioning of the power plant, the 220kV substation will remain in situ and form part of the national grid infrastructure.

5.5.3 The site access and internal roads allow access for construction and operation and maintenance vehicles. A carparking area is provided for maintenance vehicles at the west end of the substation Gas Insulated Switchgear (GIS) Building. The footprint of the proposed 220kV electricity substation compound is approximately 12,000m<sup>2</sup>. It will include the GIS building (footprint 1,130m<sup>2</sup>, height 17m) containing the switchgear, generator, battery room, workshop, storeroom, and welfare facilities etc. The compound also includes a control room building (footprint 220m<sup>2</sup>, height 8m) 2-off transformer bays, and lightning finials and monopoles.

5.5.4 On the south side of the GIS building are 2 No lattice gantries c. 20m in height supporting the overhead lines being routed to either side of the first 220kV double circuit pylon tower on the route south through Derryarkin bog for export of electricity to the national grid.

5.5.5 A 36m telecom tower is provided to the east of the substation - refer to EIAR Volume II, Appendix 5C, Figure Ref: BNM-DPS-E-2008).

5.5.6 The substation compound will be surrounded by an approximately 2.6-metre-high steel palisade fence (or as otherwise required by Eirgrid). Internal fences will also segregate different areas within the substation. The layout of electrical equipment in the substation will be designed to EirGrid specifications.

5.5.7 A local electricity back-up power supply is provided for the substation for light, heat and power purposes. A local supply is available to the existing Derrygreenagh Works. The local supply will be designed and constructed by ESB Networks. Supply will enter the site by either medium voltage overhead line or medium voltage cable. The local supply will have an associated step-down transformer (i.e., medium to low voltage) and will enter the substation building by underground cable and terminate onto the control building AC distribution board.

5.5.8 The GIS-AIS Substation hybrid design chosen for the 220kV substation provides for ease of maintenance on the components.

### 220kV Overhead Line

5.5.9 The overhead line will be carried on 'double circuit' 220kV pylon towers of both intermediate (suspension) and angle (strain) type designs over a c. 5km route from the 220kV substation in a southern direction to the Line-Cable interface compound through Derryarkin Bog and Ballybeg Bog (refer to EIAR Volume II, Appendix 5C, Figure Ref:S7060-8050-0055).

5.5.10 Towers comprise galvanised lattice steel structures characterised by having a circuit (comprising three conductors) arranged in vertical formation on either side of the tower. The conductors are attached to the supporting crossarms by means of electrical insulators. One earth wire is supported on the peak of the tower (refer to EIAR Volume II, Appendix 5C, Figure Ref:05914-DR-200, BNM-DPS-E-1002 & 1003).

5.5.11 The pylon towers will be c. 45m in height.

220kV Line-Cable Interface Compound

5.5.12 The connection from overhead line to the underground cable route takes place in the Line-Cable Interface Compound. The footprint of the compound is approximately 1,200m<sup>2</sup>. The compound contains an interface tower gantry (overall height c 20m), and the cable sealing ends (refer to EIAR Volume II, Appendix 5C, Figure Ref: BNM-DPS-E-1005). The interface compound is surrounded by a 2.6m palisade fence.

220kV Underground Connection

5.5.13 The 220kV underground cable will be routed along the existing railway line and machine pass on Bord na Móna lands (refer to EIAR Volume II, Appendix 5C, Figure Ref: BNM-S7060-8050-0055). It will utilise an existing underpass beneath the L1010 road. The cables will be buried at a depth of c. 1.5m. Each circuit will consist of three cables, each installed within their own HDPE duct and a fibre optic duct for each circuit (total of eight ducts). The cables are installed in plastic ducts to simplify the construction process.

5.5.14 The underground 220kV grid connection cabling is approximately 3.4km long, from the Line-Cable Interface Compound to the 400kV substation, with 12 no joint bays along the route arranged in pairs.

5.5.15 A minimum 4m wide paved and gated service road designed for heavy traffic will be installed to provide safe access for inspection, maintenance and fault repair along the entire cable route. A minimum easement of 5m in respect of the 220kV cable route is required and considered in the design. Joint bays, link box chambers and communication chambers are positioned on one side of the paved road for the entire route of the underground cable connection.

5.5.16 Durable route markers will be placed within line of site along the route, at bends and property boundaries. Route Markers will be 1,700mm height, 92mm width and 3.5kg in weight.

400kV Substation

5.5.17 The 400kV GIS Substation will enclose all plant components (refer to EIAR Volume II, Appendix 5C, Figure Ref: BNM-DPS-E-2002 & E-2003). The substation design and location has been carefully chosen in consideration of nearby sensitive receptors and residential properties and its proximity to the Grand Canal to the south.

5.5.18 Access to the site during construction and operation will be from the L1010 road. The site access and internal roads allow access for construction and operation and maintenance vehicles.

5.5.19 The footprint of the proposed 400kV electricity substation compound is approximately 15,300m<sup>2</sup>. The substation contains a 400kV GIS building (footprint 1,150m<sup>2</sup>, height 17m), 220kV GIS building (footprint 1,150m<sup>2</sup>, height 17m) and transformer compound (footprint 950m<sup>2</sup>, height 12m) between the GIS substations.

5.5.20 The GIS substations will contain the switchgear, a generator, battery room, workshop, storeroom, welfare facilities, etc.

5.5.21 The transformer compound contains 2 No. 200/400kV transformers and 2 No. shunt reactors.

5.5.22 On the south side of the GIS building are 2 No lattice gentries c. 28m in height supporting the overhead lines being routed to either side of the 2 No new loop-in 400kV pylon columns on the 400kV Oldstreet-Woodland line (footprint 100m<sup>2</sup>, height 32.5m,

foundation block diameter c. 5.3m, width of crossarms c. 30m). The existing OHL conductors will be terminated at these new towers and looped into the new.

- 5.5.23 A 36m telecom tower is provided to the east of the substation (refer to EIAR Volume II, Appendix 5C, Figure Ref: BNM-DPS-E-2008).
- 5.5.24 The substation compound will be surrounded by an approximately 2.6-metre-high steel palisade fence (or as otherwise required by Eirgrid). The layout of electrical equipment in the substation has been designed to Eirgrid networks specifications.

#### Peat and Soil Deposition Areas

- 5.5.25 A permanent Peat Deposition Area (PDA) is provided in the vicinity of the 400kV Substation to store excess overburden material which cannot be used in localised landscaping or backfill. Excavated peat and soil arising from the formation of the substation foundation will be placed in a designed and dedicated deposition area in close proximity on land to the north of the 400kV substation (refer to EIAR Volume II, Appendix 5C, Figure Ref: S7060-8050-0055).
- 5.5.26 It is estimated that approximately 33,000 m<sup>3</sup> of excess peat and soil will be required to be stored within the permanent PDA.
- 5.5.27 Peat will be deposited to a maximum height of 1m above ground level across a circa 75,300m<sup>2</sup> area. Once excavations are completed and following the commissioning of the project, the PDA will be allowed to naturally revegetate.
- 5.5.28 A permanent Peat Deposition Area (PDA) is provided in the vicinity of the 220kV Substation to store excess overburden material which cannot be used in localised landscaping or backfill. Excavated peat and soil arising from the formation of the substation foundation will be placed in a designed and dedicated deposition area in close proximity on land to the southwest of the 220kV substation (refer to EIAR Volume II, Appendix 5C, Figure Ref: S7060-8050-0055).
- 5.5.29 It is estimated that approximately 48,000 m<sup>3</sup> of excess peat and soil will be required to be stored within the permanent PDA.
- 5.5.30 Peat will be deposited to a maximum height of 1 m above ground level across a circa 50,200m<sup>2</sup> area. Once excavations are completed and following the commissioning of the project, the PDA will be allowed to naturally revegetate.

#### Temporary Construction Phase Works

- 5.5.31 The following temporary infrastructure will be required for the construction phase of the Electricity Grid Connection (220kV substation area and 400kV area).

##### *Temporary Contractor compounds and welfare facilities*

- 5.5.32 For the Electricity Grid Connection substations (both the 220kV and the 400kV substations) the construction and laydown area will be 2 No temporary construction compounds - north of the 220kV substation and north of the 400kV substation respectively. In addition, there will be 2 No. satellite temporary construction compounds along the OHL transmission route. The temporary construction compounds will include temporary site offices, parking, stores, and laydown areas.
- 5.5.33 Temporary toilets (i.e., porta-loos) will be used during the construction phase as part of the welfare facilities for site staff and visitors. Wastewater from portable toilets will be directed to a sealed storage tank. All wastewater will be tankered off site by an appropriately licensed waste collector to wastewater treatment plants.

*Construction Security*

- 5.5.34 Construction security is the responsibility of the EPC Contractor. Temporary perimeter fencing, gates and access control measures will be provided for the Electricity Grid Connection works. There will also be additional security fencing around the construction compounds and specific areas of the site for access control, safety and security. The temporary perimeter fencing, gates and access control measures will be replaced by the permanent installations.

*Construction lighting*

- 5.5.35 The construction phase lighting scheme will be developed by the EPC contractor and designed to provide safe working conditions for the development whilst reducing light pollution and the visual impact on the local environment. The lighting system will comply with the guidance provided by HSG38 Lighting at Work, the Society of Light and Lighting guides and EN 12464-2.

*Temporary Signage and Traffic Management*

- 5.5.36 Temporary Signage will be provided for the construction site as required by legislation.
- 5.5.37 Signage at site entrances will be provided providing outline details of the project. These signs shall have a Project contact telephone number for the general public.
- 5.5.38 All traffic management measures will comply with those outlined in the accompanying Construction Traffic Management Plan (Refer to Appendix 14H, EIAR Volume II) submitted as part of this planning application. The Construction Traffic Management Plan will remain a live working document and will be finalised by the EPC contractor in consultation with Offaly and Westmeath County Councils, prior to the commencement of development.
- 5.5.39 Traffic management and road signage will be in accordance with the Department of Transport: Traffic Signs Manual - Chapter 8: Temporary Traffic Measures and Signs for Road Works and in agreement with Offaly and Westmeath County Councils. All work on public roads will be subject to the approval of a road opening license application.



## **5.6 Components of the Gas Connection Corridor (part of the Overall Project)**

- 5.6.1 As set out in Section 5.1 above, components of the Overall Project (which do not form part of the Proposed Development), comprise a Gas Connection Corridor (tie-in connection facilitated by new AGI and underground gas pipeline routing) as presented in Table 5.3.
- 5.6.2 The Gas Connection Corridor will contain an underground gas pipe to be constructed between the Gas Pipeline to the West (BGE/77), c. 9.6km to the north of the Power Plant Area and the Power Plant. The Gas Connection Corridor is part of the Overall Project and will enable the Proposed Development to connect to the existing high pressure gas pipeline. The Gas Connection Corridor is not being applied for in the planning application for the Proposed Development (it is subject to a separate consenting process to be carried out by Gas Networks Ireland, GNI), however the Gas Connection Corridor and construction and operation is assessed in this EIAR as part of the Overall Project Site, in so far as practicable.
- 5.6.3 The preferred Gas Connection Corridor at the time of writing has been selected and identified by GNI and included for assessment purposes as part of this EIAR. The Gas Connection Corridor traverses mostly through agricultural land, west of Rochfortbridge, c. 9.6km total in length with c. 1.4km proposed to be routed within the R400 road. The route will require crossing of 2 x local roads, 1 x regional road, the M6 motorway, and will also cross 2 x streams. In order to ensure a robust assessment of the likely significant environmental effects of the Proposed Development and the Overall Project, the assessment has been undertaken for the Gas Connection Corridor route which is 1km wide.

### The Gas Connection Corridor

- 5.6.4 The gas pipeline will be designed in accordance with I.S. 328:2021 Gas Transmission Pipelines and Pipeline Installations. Materials chosen will be compatible for transmission of natural gas and hydrogen blends.
- 5.6.5 The 'Gas Connection Corridor' will include:
- An AGI at the connection to the BGE/77 Transmission Pipeline north of Rochfortbridge;
  - An underground high-pressure (HP) natural gas pipeline up to 400mm in diameter and with a maximum design pressure of up to 85 bar to transport natural gas from the BGE/77 Transmission Pipeline to the Derrygreenagh AGI;
  - A cathodic protection (CP) system;
  - Aerial gas pipeline identification marker posts and CP test posts.
- 5.6.6 In connection with and in addition to all of the above ancillary items will include:
- Surface water drainage systems including channelling, culverting, crossings and works to existing drainage ditches and systems.
- 5.6.7 In connection with the construction stage of the Gas Connection Corridor, the following will be required:
- Site establishment and preparation works, including site clearance (including vegetation removal), earthworks (including soil stripping and storage and site levelling) and excavations, temporary fencing, the creation of temporary construction access points, and the temporary alteration of the position of services and utilities apparatus and connections; and

- Temporary construction and laydown areas comprising hardstanding, laydown and open storage areas, including materials and plant storage, contractor compounds and construction staff office and welfare facilities, generators, vehicle parking facilities, security fencing and gates, external lighting, temporary roadways and haul routes and signage.

#### Temporary Construction Phase Works

- 5.6.8 Site establishment and preparation works will include site clearance (including vegetation removal), earthworks (including soil stripping and storage and site levelling) and excavations, temporary fencing, the creation of temporary construction access points, and the temporary alteration of the position of services and utilities apparatus and connections.
- 5.6.9 Temporary construction and laydown areas will be required comprising hardstanding, laydown and open storage areas, including materials and plant storage, contractor compounds and construction staff office and welfare facilities, generators, vehicle parking facilities, security fencing and gates, external lighting, temporary roadways and haul routes and signage.
- 5.6.10 The appointed contractor for the Gas Connection Corridor will secure the working width for the construction works with temporary fencing, set up initial site accommodation and welfare facilities. To ensure site security, there will be controlled points of entry to the Gas Connection corridor for all construction personnel. Laydown requirements and construction phasing will be developed during the detailed design phase by the contractor.
- 5.6.11 Temporary toilets will be used during the construction phase as part of the welfare facilities for site staff and visitors. Wastewater from toilets will be directed to a sealed storage tank, with all wastewater tankered off site by an appropriately consented waste collector to wastewater treatment plants.
- 5.6.12 The location of the proposed construction compounds will be defined by the appointed contractor.
- 5.6.13 A temporary construction phase external lighting scheme will be designed to provide safe working conditions in all areas of the Site at construction stage whilst reducing light pollution and the visual impact on the local environment.
- 5.6.14 It is expected that the extent of HGV movements will vary at different stages of the construction works in response to the activities taking place at any given time and the main HGV movements will be associated with the pipe deliveries. Levels during the construction phase will be above the operational level. Construction levels would be assessed against Transport Infrastructure Ireland (TII) guidance which recommends an assessment if there is a change exceeding 10% annual average daily traffic (AADT) on affected roads.
- 5.6.15 The Gas Connection Corridor being put forward will be accessed south off the M6 Motorway from Junction 3 onto the R400 road. The sections through agricultural land will be accessed west off the R400 road, north of the works within the R400 road. The Gas Connection Corridor being put forward will be accessed north off the M6 from Junction 4, via the N52 road, onto the L1127 road. The sections through agricultural land will be accessed west off the L1127 road adjacent to the tie-in location on the High-Pressure line.
- 5.6.16 Temporary Signage will be provided for the construction site as required by legislation.

- 5.6.17 Traffic management and road signage will be in accordance with the Department of Transport: Traffic Signs Manual - Chapter 8: Temporary Traffic Measures and Signs for Road Works and in agreement with Offaly and Westmeath County Councils. All work on public roads will be subject to the approval of a road opening license application.



## 5.7 Construction Phase

5.7.1 The following section presents details of the construction phase for the Proposed Development and Overall Project in respect of:

- Power Plant Area;
- Electricity Grid Connection; and
- Gas Connection Corridor.

### Environmental Management for Proposed Development

5.7.2 All activities on the site of the Proposed Development are provided for in the Construction and Environmental Management Plan (CEMP). A CEMP has been prepared for the Proposed Development and is included in Appendix 5A (refer to EIAR Volume II) of this EIAR. The CEMP sets out the key environmental considerations to be taken into account by the contractor during construction of the Proposed Development. The CEMP also details the mitigation and monitoring measures to be implemented in order to comply with the environmental commitments outlined in the EIAR. The contractor will be contractually obliged to comply with all such measures. It is intended that the CEMP would be updated prior to the commencement of the development, to include any additional mitigation measures, conditions and or alterations to the EIAR and application documents that may emerge during the course of the planning process and would be submitted to the Planning Authority for written approval in advance of commencement of any construction works on site.

### *Construction waste*

5.7.3 Waste will be generated during all stages of the construction works. A Site Waste Management Plan is incorporated into the CEMP and all relevant contractors will be required to seek to minimise waste arising at source and, where such waste generation is unavoidable, to maximise its recycling and reuse potential. Recycling of materials will take place off-site at appropriately licensed facilities where noise and dust are more easily managed and less likely to impact on surrounding properties.

### *Refuelling*

5.7.4 Wherever possible, vehicles will be refuelled off-site. This will be the case for regular, road-going vehicles. However, for construction machinery that will be based on-site continuously, a limited amount of fuel will have to be stored on site in bunded areas. On-site refuelling of machinery will be carried out at dedicated refuelling locations using a mobile double skinned fuel bowser or fuel truck. The fuel bowser/truck will be re-filled off site and will be transported to where machinery is located. It is not practical for all vehicles to travel back to a single refuelling point, given the scale of the site. A spill kit will be carried on vehicles in the event of any accidental spillages. The fuel bowser will be parked on a level area in the construction compound when not in use. Only designated trained and competent operatives will be authorised to refuel plant on site. Mobile measures such as drip trays, spill kits and fuel absorbent mats will be available and will be used when required during all refuelling operations.

### *Concrete Deliveries and Pours*

5.7.5 Ready-mixed concrete will be used during the construction phase, with all concrete being delivered from local batching plants in sealed concrete delivery trucks. The use of ready-mixed concrete deliveries will eliminate any potential environmental risks of on-site batching. Before leaving site, washing of the delivery truck chute will be minimised and restricted to designated wash out areas. Concrete trucks will be washed out fully at the off-site batching plant, where facilities are already in place. The small volume of water

that will be generated from washing of the concrete lorry's chute will be directed into a temporary lined impermeable containment area, or a Siltbuster-type concrete wash unit or equivalent. This type of Siltbuster unit catches the solid concrete and filters and holds wash liquid for pH adjustment and further solids separation. The residual liquids and solids will be removed off-site by an appropriately authorised waste collector for disposal at an authorised waste facility. Where temporary lined impermeable containment areas are used, such containment areas are typically built using straw bales and lined with an impermeable membrane.

- 5.7.6 The areas are covered when not in use to prevent rainwater collecting. In periods of dry weather, the areas can be uncovered to allow much of the water to be lost to evaporation. At the end of the concrete pours, any of the remaining liquid contents will be tankered off-site and transported to an appropriately authorised facility. Any solid contents that will have been cleaned down from the chute will have solidified and can be broken up and disposed of along with other construction waste.
- 5.7.7 In general, concrete deliveries are to be carried out outside peak periods to minimise impact on school and work commuter traffic.
- 5.7.8 The risks of pollution arising from concrete deliveries will be further reduced by the following:
- Concrete truck hoppers will not be washed out on the site but will be directed back to their batching plant for washout.
  - Site roads will be constructed/upgraded to the required standard to allow transport of the components required for the project. Concrete delivery trucks will be able to access all areas where the concrete will be needed. No concrete will be transported around the site in open trailers or dumpers to avoid spillage while in transport.
  - The arrangements for concrete deliveries to the site will be agreed with suppliers before work starts, agreeing routes, prohibiting on-site washout and to agree emergency procedures.
  - Clearly visible signage will be placed in prominent locations close to concrete pour areas specifically stating washout of concrete lorries is not permitted on the site.
- 5.7.9 Special procedures will be adopted in advance of and during all concrete pours to minimise the risk of pollution. These are defined in the CEMP and include:
- Using weather forecasting to assist in planning large concrete pours and avoiding large pours where prolonged periods of heavy rain is forecast.
  - Restricting concrete pumps and machine buckets from slewing over watercourses (including drains and ditches) while placing concrete.
  - Ensuring that excavations are sufficiently dewatered before concreting begins and that dewatering continues while concrete sets.
  - Ensuring that covers are available, and used, when necessary, for freshly placed concrete to avoid the surface washing away in heavy rain.
  - Surplus concrete after completion of a pour will be taken off-site and disposed of at an appropriately authorised facility.

#### *Dust Suppression*

- 5.7.10 In periods of extended dry weather, dust suppression may be necessary along the site roads to ensure dust does not cause a nuisance. Bowser or water spreader to dampen down haul roads and site compounds to prevent the generation of dust. Silty or oily

water will not be used for dust suppression. Water bowser movements will be monitored to limit increased runoff.

#### *Vehicle Washing*

- 5.7.11 Wheels or vehicle underbodies are often washed before leaving sites to prevent the build-up of mud on public (and site) roads. Site roads will already be constructed before other road-going trucks begin to make regular or frequent deliveries to the site (e.g., with steel or concrete). The site roads will comprise granular fill, and so the public road-going vehicles will not be travelling over soft or muddy ground where they might pick up mud or dirt.
- 5.7.12 A wheel wash facilities will be provided. A wheel wash will be located at each of the construction entrances as shown on the site layout drawings included in EIAR Volume II, Appendix 5C.
- 5.7.13 The contractor will be responsible for ensuring that all vehicles egressing the site have used the wheel wash facilities. However, a road sweeper will be made available by the contractor for the cleaning of public roads in the event that they are dirtied by trucks associated with the Proposed Development.

#### *Best Practice Design and Construction & Environmental Management Methodology*

- 5.7.14 Prior to commencement of construction works the contractor will draw up detailed Method Statements which will be informed by this Outline Construction Methodology, environmental protection measures included within the planning application, measures proposed within the CEMP, and the guidance documents and best practice measures listed below. This method statement will be adhered to by the contractors and will be overseen by the Project Manager, Environmental Manager and ECoW where relevant.
- 5.7.15 The following documents will contribute to the preparation of the method statements in addition to those measures proposed below:
- Inland Fisheries Ireland (2016) *Guidelines on Protection of Fisheries during Construction Works in and Adjacent to Waters*. Inland Fisheries Ireland, Dublin;
  - National Roads Authority (2008) *Guidelines for the Crossing of Watercourses during the Construction of National Road Schemes*. National Roads Authority, Dublin;
  - E. Murnane, A. Heap and A. Swain. (2006) *Control of water pollution from linear construction projects*. Technical guidance (C648). CIRIA;
  - E. Murnane et al., (2006) *Control of water pollution from linear construction projects*. Site guide (C649). CIRIA.
  - Murphy, D. (2004) *Requirements for the Protection of Fisheries Habitat during Construction and Development Works at River Sites*. Eastern Regional Fisheries Board, Dublin;
  - H. Masters-Williams et al (2001) *Control of water pollution from construction sites. Guidance for consultants and contractors (C532)*. CIRIA;
  - Enterprise Ireland (unknown). *Best Practice Guide (BPGCS005) Oil storage Guidelines*;
  - Law, C. and D'Aleo, S. (2016) *Environmental good practice on site pocketbook*. (C762) 4th edition. CIRIA;
  - CIRIA 92023), *Environmental good practice on site guide (fifth edition) (C811)*.

5.7.16 The proposed works will be carried out by employing accepted good work practices during construction, and environmental management measures such as those discussed below. Please note that the following measures will be supplemented by further specific environmental protection measures that will be included in method statements prepared for specific tasks during the works and will form part of the detailed CEMP that will be provided prior to construction. This Construction Methodology's measures listed below are non-exhaustive and should be read in conjunction with the CEMP that accompanies this planning application and all its mitigation measures as well as the NIS and all other reports that accompany this planning application.

- All materials will be stored within temporary compounds, see CEMP temporary construction compound details, and transported to the works zone immediately prior to construction;
- Weather conditions will be taken into consideration when planning construction activities to minimise risk of run off from site;
- Provision of 50m exclusion zones and barriers (silt fences) between any excavated material and any surface water features to prevent sediment washing into the receiving water environment;
- If dewatering is required as part of the proposed works e.g. in wet areas, water must be treated prior to discharge;
- The contractor shall ensure that silt fences are regularly inspected and maintained during the construction phase;
- If very wet ground must be accessed during the construction process bog mats/aluminium panel tracks will be used to enable access to these areas by machinery. However, works will be scheduled to minimise access requirements during winter months;
- The contractor shall ensure that all personnel working on site are trained in pollution incident control response. A regular review of weather forecasts of heavy rainfall is required, and the Contractor is required to prepare a contingency plan for before and after such events;
- The contractor will carry out regular visual examinations of local watercourses that may be impacted by the proposed works during the construction phase to ensure that sediment is not above baseline conditions. In the unlikely event of water quality concerns, the Environmental Manager and ECoW will be consulted;
- Excavations will be left open for minimal periods to avoid acting as a conduit for surface water flows.
- Only emergency breakdown maintenance will be carried out on site. Emergency procedures and spillage kits will be available and construction staff will be familiar with emergency procedures.
- Appropriate containment facilities will be provided to ensure that any spills from vehicles are contained and removed off site. Adequate stocks of absorbent materials, such as sand or commercially available spill kits shall be available;
- Entry by plant equipment, machinery, vehicles and construction personnel into watercourses or wet drainage ditches shall not be permitted. All routes used for construction traffic shall be protected against migration of soil or wastewater into watercourses;

- Cabins, containers, workshops, plant, materials storage and storage tanks shall not be located near any surface water channels and will be located beyond the 50m hydrological buffer at all times.

#### Community Consultation and Liaison

- 5.7.17 There shall be an ongoing commitment by the Project Team to maintain community consultation and liaison throughout the construction period for the Proposed Development and Overall Project. Signage will be provided at Site entrances which shall have a Project contact telephone number where the public will be able to leave messages in relation to the Proposed Development construction. A liaison officer will be appointed to manage the calls/messages and any subsequent actions pertaining to these. Further information on community consultation and liaison is outlined in the CEMP in EIAR Appendix 5A.
- 5.7.18 Details of community engagement and consultation to date is defined in EIAR Chapter 6: Consultation of this EIAR.

#### Overall Construction Programme

- 5.7.19 The construction phase for the Proposed Development and Overall Project will be 39 months, the final details of which will be determined by the EPC Contractor and presented in a Construction Environmental Management Plan (CEMP) which will be agreed with the planning authority. The CEMP for the Proposed Development is presented in Appendix 5A (refer to EIAR Volume II). Estimates for the duration of the construction works are included in Table 5.5.

**Table 5. 5: Construction Phase Programme**

ACTIVITY	PROPOSED CONSTRUCTION YEAR															
	Year 1				Year 2				Year 3				Year 4			
	Sept Oct Nov 2024	Dec Jan Feb 2025	Mar Apr May 2025	June July Aug 2025	Sept Oct Nov 2025	Dec Jan Feb 2026	Mar Apr May 2026	June July Aug 2026	Sept Oct Nov 2026	Dec Jan Feb 2027	Mar Apr May 2027	June July Aug 2027	Sept Oct Nov 2027	Dec Jan Feb 2028	Mar Apr May 2028	June July Aug 2028
	<b>Power Plant Area</b>															
Enabling works and mobilisation (inc. site clearance and demolition)	x	x														
Civil and Structural (inc. ground works, piling and foundations)			x	x	x	x	x	x	x							
Erect steelwork and cladding				x	x	x	x	x	x							
Mechanical and electrical works					x	x	x	x	x	x	x	x				
Commissioning and testing								x	x	x	x	x	x			
<b>Electricity Grid Connection</b>																
Enabling works and site mobilisation	x	x	x													
Civil Works - Substation (220kV + 400kV) and interface compound	x	x	x													
Cabling and tower works									x	x	x					
Mechanical and electrical fitout			x	x	x	x	x									
Commissioning and testing								x	x	x	x					
Energisation											x					
<b>Gas Connection Corridor</b>																
Route and site preparation, surveys and veg removal.						x	x									
Soil stripping and fencing. Construction of AGI.							x	x	x							
Pipeline trenching, road/track/watercourse crossing							x	x	x							
AGI Construction							x	x	x							
Commissioning and testing												x				
Reinstatement												x	x	x		

Source – Fichtner Consulting Engineers Limited (2023)



Power Plant Area – Construction Phase

*Power Plant Area – Construction Site Management*

- 5.7.20 The Applicant will appoint an Engineering, Procurement Construction (EPC) Contractor for the duration of the Construction Phase of the Power Plant Area. The contractor will appoint subcontractors to undertake all the specific construction and civil works. The Applicant is committed to ensure a safe working environment for all employees and contractors.
- 5.7.21 Construction works will be restricted to take place during the hours of 0700hrs to 1900hrs (Monday to Friday) and 0800hrs to 1300hrs (Saturday) with the exception of commissioning and specific engineering works (e.g., Non-destructive testing, internal erection concrete pours) which could take place outside these hours, as and when agreed with the planning authority.

*Power Plant Area – Construction Materials*

- 5.7.22 The construction of the Power Plant Area will require the relevant personnel, machinery and materials. Equipment and materials are outlined in Table 5.6.

**Table 5. 6: Power Plant Area –Estimated Construction Works**

EQUIPMENT	MATERIALS
<ul style="list-style-type: none"> <li>• JCB Type excavators (20, 25, 35 ton)</li> <li>• 360 tracked excavators (13 ton normally, 22 tonne for rock breaker)</li> <li>• Tracked/wheeled dumpers / tractors and trailers</li> <li>• Compactors and rollers</li> <li>• Piling rigs</li> <li>• Telehandlers</li> <li>• Wheeled, tracked and fixed cranes</li> <li>• Hoists</li> <li>• Pumps</li> <li>• Power and hand tools</li> <li>• Generators</li> <li>• Cutting and welding equipment</li> <li>• Scaffolding</li> </ul>	<ul style="list-style-type: none"> <li>• Stone</li> <li>• Asphalt</li> <li>• Geotextile</li> <li>• Lighting fixtures and fittings</li> <li>• Paving.</li> <li>• Fencing.</li> <li>• Steelwork</li> <li>• Concrete</li> <li>• Timber</li> <li>• Cladding</li> <li>• Doors</li> <li>• Piping inc fixtures and fittings</li> <li>• Cabling inc fixtures and fittings</li> <li>• Switchgear</li> <li>• Instrumentation and control systems</li> </ul>

- 5.7.23 The volumes of granular fill (sand and stone) required for the construction of the Power Plant Area, outlined in Table 5.7 below, have been calculated based on the Power Plant Area component footprints, the anticipated excavation levels to suitable formation or suitable subgrade, and the proposed final levels for the infrastructure components. Construction grade granular fill and higher quality, final surfacing fill (including sand) will both be required for the construction of the Proposed Development.

**Table 5. 7: Power Plant Area - Volume of Granular Fill Required**

DEVELOPMENT COMPONENT	GRANULAR FILL REQUIRED VOLUME
Power Plant Area - Main	163,000m <sup>3</sup>
Power Plant Area - AGI	22,000m <sup>3</sup>
Power Plant Area - Discharge Routes	8,000m <sup>3</sup>

*Power Plant Area – Construction Methodology*

- 5.7.24 For the Power Plant Area site, the construction methodology and sequencing will be decided by the EPC contractor in line with their construction philosophy, equipment delivery schedules and site constraints.
- 5.7.25 The general construction methodology and sequencing is anticipated to be as follows.
- 5.7.26 The EPC contractor will prepare and level the Power Plant Site, followed by piling and excavation for main foundations, e.g., stack, HRSG, turbine hall etc. The lighter buildings may be piled or have raft foundations.
- 5.7.27 Underground services such as drainage and earthing will be installed, and the foundations constructed.
- 5.7.28 Once the foundations are complete erection of equipment (HRSG, ACC, Storage tanks, OCGT modules etc) and building structures (Turbine Hall, water treatment plant, administration building etc) will commence.
- 5.7.29 Once the building structure is in place the EPC contractor will commence the erection of the plant within them. In some cases, e.g. the CCGT gas and steam turbines and generator, the erection may take place before the structure is complete for constructability reasons.
- 5.7.30 As plant and systems are completed, they will be commissioned until the whole plant is commissioned.
- 5.7.31 Temporary construction works will generally be removed and remediated, and landscaping of the Power Plant Area completed in line with the agreed landscaping plan.
- 5.7.32 Once commissioning is complete the plant will undergo testing before handover from the EPC contractor to Bord na Móna Powergen Limited.

Power Plant Area – Construction Site Access and Traffic

- 5.7.33 Details of the construction site access and traffic are included in EIAR Chapter 14.
- 5.7.34 All HGV deliveries to the site will be directed to approach the site along the R400 road from the direction of the junction with the M6.
- 5.7.35 A detailed Construction Traffic Management Plan (CTMP) is provided in EIAR Appendix 14H specifying details relating to traffic management and included in the Construction Environmental Management Plan (CEMP) prior to the commencement of the construction phase of the Power Plant Area. The CTMP will be agreed with the local authority and An Garda Síochána prior to construction works commencing on site.

Electricity Grid Connection – Construction Phase

*Electricity Grid Connection – Construction Site Management*

- 5.7.36 The Applicant will appoint an Engineering, Procurement Construction (EPC) Contractor for the duration of the Construction Phase of the Electricity Grid Connection. The contractor will appoint subcontractors to undertake all the specific construction and civil works. The Applicant is committed to ensure a safe working environment for all employees and contractors.
- 5.7.37 Construction works will be restricted to take place during the hours of 0700hrs to 1900hrs (Monday to Friday) and 0800hrs to 1300hrs (Saturday) with the exception of commissioning and specific engineering works (e.g., Non-destructive testing, concrete pours) which could take place outside these hours, as and when agreed with the planning authority.

*Electricity Grid Connection – Construction Programme*

- 5.7.38 The construction phase for the Electricity Grid Connection will be 33 months, the final details of which will be determined by the EPC Contractor and presented in a Construction Environmental Management Plan (CEMP) which will be agreed with the planning authority. A CEMP is presented in Appendix 5A (refer to EIAR Volume II). Estimates for the duration of the construction works are included in Table 5.5. The final connection to the 400kV line would take place during the appropriate period to avoid disruption to the electricity network in consultation with TSO.

**Table 5. 8: Electricity Grid Connection - Estimated Construction Duration**

DEVELOPMENT ELEMENT	ESTIMATED CONSTRUCTION DURATION
Construct 220kV Substation	18 months
Overhead Line Route	6 months
Underground Cable Route	6 months
Construct 400kV Substation	18 months
Connection to Existing OHL and Commissioning	8 weeks
<b>Total</b>	20 Months

*\*Note: some construction activities will run concurrently.*

*Electricity Grid Connection – Construction Materials*

- 5.7.39 The proposed construction scope of the Electricity Grid Connection will require the relevant personnel, machinery and materials which is as follows for the substation sites:

**Table 5. 9: Electricity Grid Connection – Substations Estimated Construction Works**

EQUIPMENT	MATERIALS
<ul style="list-style-type: none"> <li>• Approximately 10 No. Electrical/Civil Crews</li> <li>• Wheeled and Tracked Excavators</li> <li>• 360° tracked excavators (13 ton normally, 22 tonne for rock breaker)</li> <li>• Tracked dumpers / tractors and trailers</li> <li>• Cranes</li> <li>• Hoists</li> </ul>	<ul style="list-style-type: none"> <li>• Stone</li> <li>• Asphalt</li> <li>• Geotextile</li> <li>• Lighting fixtures and fittings</li> <li>• Paving.</li> <li>• Fencing.</li> <li>• Steelwork</li> <li>• Concrete</li> </ul>

<ul style="list-style-type: none"> <li>• Generator</li> <li>• Scaffolding</li> <li>• Pumps</li> <li>• Power and hand tools</li> <li>• Generators</li> <li>• Cutting and welding equipment</li> <li>• Piling rigs</li> </ul>	<ul style="list-style-type: none"> <li>• Timber</li> <li>• Cladding</li> <li>• Doors</li> <li>• Piping inc fixtures and fittings</li> <li>• Cabling inc fixtures and fittings</li> <li>• Switchgear</li> <li>• Instrumentation and control systems</li> </ul>
---	---

5.7.40 The proposed construction scope will require the relevant personnel, machinery and materials which are as follows for the OHL.

**Table 5. 10: Electricity Grid Connection – OHL Estimated Construction Works**

EQUIPMENT	MATERIALS
<ul style="list-style-type: none"> <li>• 5 No. operatives</li> <li>• 4x4 vehicle</li> <li>• Winch</li> <li>• Tractor and trailer</li> <li>• Crane</li> <li>• Teleporter</li> <li>• Chains / small tools</li> <li>• Tracked Excavator</li> <li>• Tracked Dumper</li> <li>• Sheet Piling Rig</li> </ul>	<ul style="list-style-type: none"> <li>• Lattice steel mast</li> <li>• Insulators</li> <li>• Electrical connections</li> <li>• Concrete (foundation)</li> <li>• Aggregate</li> <li>• Geotextile</li> </ul>

5.7.41 The proposed construction scope will require the relevant personnel, machinery and materials which is as follows for the underground cable:

**Table 5. 11: Electricity Grid Connection – Underground Cable Estimated Construction Works**

EQUIPMENT	MATERIALS
<ul style="list-style-type: none"> <li>• 5 No. operatives</li> <li>• 4x4 vehicle</li> <li>• Tractor and trailer</li> <li>• Teleporter</li> <li>• Chains / small tools</li> <li>• Tracked Excavator</li> <li>• Tracked Dumper</li> </ul>	<ul style="list-style-type: none"> <li>• Insulators</li> <li>• Steel guy ropes</li> <li>• Connection clamps</li> <li>• Electrical connections</li> <li>• Crushed rock and timber (foundation)</li> <li>• Crushed rock and concrete (alternative foundation)</li> <li>• Geotextile</li> </ul>

5.7.42 The volumes of granular fill (sand and stone) required for the construction of the Electricity Grid Connection, outlined in Table 5.12 below, have been calculated based on the Electricity Grid Connection component footprints, the anticipated excavation levels to suitable formation or suitable subgrade, and the proposed final levels for the infrastructure components. Construction grade granular fill and higher quality, final surfacing fill (including sand) will both be required for the construction of the Proposed Development.

**Table 5. 12: Electricity Grid Connection - Volume of Granular Fill Required**

<b>DEVELOPMENT COMPONENT</b>	<b>GRANULAR FILL REQUIRED VOLUME</b>
Electricity Grid Connection – 220kV substation	34,000m <sup>3</sup>
Electricity Grid Connection – Overhead line, line-cable interface compound, and underground cable	41,000m <sup>3</sup>
Electricity Grid Connection – 400kV substation	44,000m <sup>3</sup>

*Electricity Grid Connection – Construction Methodology*

*220 & 400kV Substations – Construction Methodology*

- 5.7.43 For the 220 and 400kV substations the construction methodology and sequencing will be decided by the EPC contractor in line with their construction philosophy, equipment delivery schedules and site constraints.
- 5.7.44 The general construction methodology and sequencing is anticipated to be as follows.
- 5.7.45 The EPC contractor will prepare and level the substation sites, followed by piling and excavation for main foundations.
- 5.7.46 Underground services such as drainage and earthing will be installed, and the foundations constructed.
- 5.7.47 Once the foundations are complete erection of equipment (Air Insulated Switchgear, Communications towers etc) and the building structures will commence.
- 5.7.48 Once the building structure is in place the EPC contractor will commence the erection of the plant within them.
- 5.7.49 As equipment and systems are completed, they will be commissioned until each substation is commissioned.
- 5.7.50 Once commissioning is complete the substation will undergo testing.
- 5.7.51 Temporary construction works will generally be removed and remediated and landscaping of the substation areas completed in line with the agreed landscaping plan.
- 5.7.52 On completion of testing of the Electricity Grid Connection the substation is handed over from the EPC contractor to Bord na Móna Powergen Limited.

*220kV Overhead Line – Construction Methodology*

- 5.7.53 For the 220kV overhead line the construction methodology and sequencing will be decided by the EPC contractor in line with their construction philosophy, equipment delivery schedules and site constraints.
- 5.7.54 The general construction methodology and sequencing is anticipated to be as follows.
- 5.7.55 The removal of vegetation (hedges and trees), topsoil stripping and storage, pre-construction drainage measures and construction of temporary roads etc.
- 5.7.56 The EPC contractor will prepare and level each tower site followed by excavation for the tower foundations.
- 5.7.57 An earth mat will be installed, and the foundations constructed.
- 5.7.58 Construction of the transmission tower bases and erection of the transmission tower steelwork. The base and body sections etc of each tower will be assembled next to their respective foundations. The towers sections are lifted into place and joined together.

- 5.7.59 Installation of the insulators and stringing of the conductors and earth wire.
- 5.7.60 Temporary construction works will be removed and reinstatement works will be carried out.
- 5.7.61 On completion of testing of the Electricity Grid Connection the overhead line is handed over from the EPC contractor to Bord na Móna Powergen Limited.

*400kV Overhead Line Loop in – Construction Methodology*

- 5.7.62 The construction methodology of the new 400kV towers for the loop in from the existing Oldstreet - Woodland 400kV line will be the same as for the 220kV towers. There will be additional safety precautions in place reflecting working in the vicinity of a live line and to mitigate any potential risk to the operational line during construction works.
- 5.7.63 Disconnection of existing conductors and connection of the new towers to the existing grid will be carried out by ESBN and at that point in time live commissioning and testing of the Electricity Grid Connection can start.

*220kV Underground connection – Construction Methodology*

- 5.7.64 For the 220kV underground connections the construction methodology and sequencing will be decided by the EPC contractor in line with their construction philosophy, equipment delivery schedules and site constraints.
- 5.7.65 The ducts for the cables of the underground connections will primarily be installed using an open cut trenching technique.
- 5.7.66 The general construction methodology and sequencing is anticipated to be as follows.
- 5.7.67 The removal of vegetation (hedges and trees), topsoil stripping and storage, pre-construction drainage measures and construction of temporary roads etc.
- 5.7.68 The EPC contractor will prepare and level the line-cable interface compound and joint bays areas followed by excavation and construction of the compound foundations and the joint bays.
- 5.7.69 The equipment and structures of the line-cable interface compound are installed.
- 5.7.70 Excavation of the cable trenches, installation of the duct bedding and ducts, backfilling and reinstatement will generally take place in short sections. The short sections minimise the amount of ground disturbed at any one time and minimises the potential for drainage runoff to pick up silt or suspended solids. There may be more than one work front for this activity depending on schedule requirements.
- 5.7.71 Once the trenching works is complete between joint bays cable installation can take place.
- 5.7.72 Cables are supplied on large drums. Each drum contains a single length of cable. The length of the cable is equal to the distance between a pair of joint bays plus an installation and jointing margin.
- 5.7.73 A drum is placed adjacent to a joint bay and the cable pulled from the drum through a duct to the receiving joint bay by a draw cable attached to a winch. The operation is repeated until all cables are installed in their ducts between the joint bays. Cable pulling then proceeds to what was the receiving joint bay and the cables are pulled from there to the next joint bays on the route until the cables are installed over the complete route.
- 5.7.74 The cable sections between the joint bays will be tested and the six cable ends in each joint bay joined together by a specialist machine and the joints tested. Once testing is complete the covers of the joint bays will be installed.



- 5.7.75 At the line-cable interface compound and the 400kV substation the cables will be terminated onto the interfacing equipment cable sealing ends and tested.
- 5.7.76 The permanent access road will then be completed, temporary construction works will be removed and reinstatement works will be carried out.
- 5.7.77 On completion of testing of the Electricity Grid Connection the overhead line is handed over from the EPC contractor to Bord na Móna Powergen Limited.

Gas Connection Corridor – Construction Phase

- 5.7.78 It is anticipated that GNI will appoint an Engineering, Procurement and Construction (EPC) Contractor for the duration of the Construction Phase of the works within the gas connection corridor. The contractor will appoint subcontractors to undertake all the specific construction and civil works.
- 5.7.79 It is anticipated that construction works will take place during the hours of 0700hrs to 1900hrs (Monday to Friday) and 0800hrs to 1300hrs (Saturday) with the exception of commissioning and specific engineering works (e.g., Non-destructive testing, concrete pours, Horizontal Directional Drilling (HDD)) which could take place outside these hours, as and when agreed with the planning authority.
- 5.7.80 The GNI application will include a request for a construction easement and a permanent maintenance easement in relation to gas pipeline.

*Gas Connection Corridor – Construction Programme*

- 5.7.81 It is anticipated that the duration of site preparation, construction and commissioning will be determined by the Contractor and presented in a Construction Environmental Management Plan (CEMP) for the Gas Connection Corridor. It is considered the construction works for the Gas Connection Corridor would take place over a 12-24 month period with the bulk of the work typically taking place between February to October in a single year.

*Gas Connection Corridor – Construction Materials*

- 5.7.82 It is expected that the construction scope of the works in the Gas Connection Corridor is estimated to require the relevant personnel, machinery and materials outlined in Table 5.13.

**Table 5. 13: Gas Connection Corridor – Estimated Construction Works**

EQUIPMENT	MATERIALS
<ul style="list-style-type: none"> <li>• Tracked and wheeled excavators</li> <li>• 360 tracked excavators</li> <li>• Tracked and wheeled dumpers / tractors, trailers, flatbed wagons</li> <li>• Horizontal direction drilling rig, Auger bore equipment</li> <li>• Cranes</li> <li>• Telehandlers</li> <li>• Hoists</li> <li>• Hand and power tools</li> <li>• Generators</li> <li>• Welding sets</li> </ul>	<ul style="list-style-type: none"> <li>• Stone</li> <li>• Geotextile</li> <li>• Lighting</li> <li>• Fencing.</li> <li>• Concrete</li> <li>• Timber</li> <li>• Cladding</li> <li>• Drilling mud</li> <li>• Piping and coating materials</li> </ul>

*Gas Connection Corridor – Construction Methodology*

- 5.7.83 The majority of the pipeline will likely be installed through an open cut method whereby a trench will be excavated, and the pipe laid approximately 1.2m below ground. Once the pipeline is installed, the trench will be backfilled, and the land reinstated as far as possible to its original condition.
- 5.7.84 It is expected that crossings of ditches, minor water courses and roads will be by open cut methods and appropriate diversion techniques. Major water courses and road crossing may require the use of techniques such as horizontal directional drilling, auger or thrust boring etc.
- 5.7.85 The general construction methodology and sequencing is anticipated to be as follows.
- 5.7.86 The removal of vegetation (hedges and trees), establishment of site facilities, pipe dumps, erecting of safety barriers, pre-construction drainage measures and construction of temporary roads etc.
- 5.7.87 Topsoil stripping and fencing works will then take place with the topsoil stored for reuse along the pipe route.
- 5.7.88 Excavation of the pipe trench, laying of the pipe bedding and installation of the pipe and cathodic protection system, testing, backfilling and reinstatement will follow on from the topsoil stripping and fencing works.
- 5.7.89 Topsoil stripping, piping installation and reinstatement will take place in sections. Construction in sections minimises the amount of ground disturbed at any one time and minimises the potential for drainage runoff to pick up silt or suspended solids. There may be more than one work front for these activities depending on schedule requirements.
- 5.7.90 Minor crossing activities will take place at the same time as the pipe is laid. Major crossing activities involving HDD, auger or thrust boring require specialist teams and are generally carried out before the pipe reaches the crossing area.
- 5.7.91 Excavation of the cable trenches, installation of the duct bedding and ducts, backfilling and reinstatement will generally take place in short sections. The short sections minimise the amount of ground disturbed at any one time and minimising the potential for drainage runoff to pick up silt or suspended solids. There may be more than one work front for this activity depending on schedule requirements.
- 5.7.92 The gas pipeline will be hydraulically pressure tested. This will either be in sections or the complete line depending on topography, water source availability and disposal route.
- 5.7.93 For the gas pipeline AGI's the contractor will prepare and level the sites, excavate the foundations, install underground services, construct the foundations, erect equipment and structures, fit out the structures and test the AGI's.
- 5.7.94 Commissioning of the overall gas transmission system will take place once the pipeline and AGI's are complete and the connection to the national gas transmission system is made.
- 5.7.95 At the end of commissioning the gas pipeline is pressurised and ready for use.

## 5.8 Proposed Operational Phase

### Power Plant Area – Operational Phase

#### *Industrial Emissions Licence*

5.8.1 The Industrial Emissions Licence Area will likely comprise a smaller area within the Power Plant Area to include those areas required for the operational phase under Class activity 2.1 of the First Schedule of the EPA Act as amended and excludes components such as the Derrygreenagh AGI and requirements limited to the construction phase namely upgrades to the public road network and peat deposition area. While the Industrial Emissions Licence Area will likely comprise a smaller area within the footprint of the Power Plant Area once operational, for the purposes of this EIAR, the entirety of the wider Power Plant Area has been considered in respect of the overall assessments of the construction, operational and decommissioning phases, for completeness. The Derrygreenagh Thermal Power Plant Area will comply with the requirements of the European Union (Large Combustion Plants) Regulations 2012 S. I. No. 566 of 2012 under its IE Licence (to be applied for) so that any impacts of emissions to air, soil, surface and groundwater, and effects on the environment and human health, will be minimised and avoided where possible. An IE licence is required for operation of the Power Plant Area in accordance with Activity 2.1 of the First Schedule of the EPA Act as amended 'Combustion of fuels in installations with a total rated thermal input of 50 MW or more.'

5.8.2 The Power Plant Area will be operated in line with the IE Licence (to be applied for) and the plant vendors Operation and Maintenance (O&M) manuals. The operator will implement and maintain an Environment Management System (EMS) which will be certified to International Standards Organisation (ISO) 14001. The EMS will establish the requirements and procedures required to ensure that the Site is operating to the appropriate standard.

5.8.3 Sampling and analysis of pollutants will be carried out where required including monitoring of exhaust emissions levels using Continuous Emission Monitoring Systems (CEMS) prior to discharge from the stacks, in accordance with the Industrial Emission (IE) Licence.

#### *Hazard Prevention and Emergency Planning*

5.8.4 Measures to prevent the risks of fire, flooding, spillages or other potentially major incidents will be embedded in the design of the Proposed Development.

5.8.5 Measures to prevent potentially major incidents include:

- Compliance with all relevant health, safety and environmental legislation;
- Design, build and operation in accordance with good industry practice;
- Regular maintenance and inspections to reduce the risk of equipment failures;
- Bunded or double-skinned storage areas for liquid chemicals;
- Regular maintenance and Site housekeeping to reduce the likelihood of leakages and improve leakage detection; and
- Spill kits stored on Site.

5.8.6 A site-specific Health and Safety Plan prepared in line with the requirements of ISO 45001 covering operation will be prepared to ensure compliance with relevant health and safety legislation.

- 5.8.7 Procedures will be in place to clearly outline the responsibilities, actions and communication channels for operational staff and personnel on how to deal with emergencies should they occur. Staff will also receive the level of training required for their role and position. This will include dealing with events such as fires, spillages, flooding, etc. Such measures will be included in the site operating and management system and regulated by EPA through the IE Licence for the site.

*Start-Up and Shut-Down*

- 5.8.8 The Proposed Development will be started and stopped automatically by an integrated control system, under the supervision of trained operations personnel. This will be in response to the requirements of the electricity grid operator, EirGrid's, request for power & system services. The plant is specifically designed to start-up, shut-down and ramp (change its output) rapidly in response to the requirement for power from the electricity grid.

*Fuel*

- 5.8.9 The CCGT and OCGT will fire primarily natural gas to generate power, however the turbines will also have the functionality to fire on locally stored Secondary Fuel (distillate and/or HVO).
- 5.8.10 Operation using secondary fuel is only expected to occur during an emergency scenario (such as loss of natural gas transmission pipeline pressure during a period of high electricity demand) and during short grid code compliance tests to confirm the readiness of the turbines to respond to a call to fire secondary fuel.
- 5.8.11 The capability of the Power Plant to operate up to a 5% blend of hydrogen by design offers the potential for the Power Plant carbon emissions to reduce over the period to 2050, as and when the required policies and supply chains for hydrogen are developed.

*Commissioning Stage*

- 5.8.12 Commissioning of the Power Plant Area will be carried out by the EPC Contractor. During commissioning The Power Plant Area will be operated in line with the IE Licence (to be applied for) and the EPC Contractors commissioning procedures. The EPC Contractor will implement and maintain an Environment Management System (EMS) which will be certified to International Standards Organisation (ISO) 14001. The EMS will establish the requirements and procedures required to ensure that the Site is operating to the appropriate standard.
- 5.8.13 Commissioning takes place in two stages: cold commissioning and hot commissioning. Once the cold and hot commissioning has been successfully completed the facility will then be offered for reliability run and tests on completion.
- 5.8.14 Cold commissioning is the initial period of commissioning where pumps, fans and other components are run at the drive level and circuit cleaning takes place. Cable continuity checks and control and instrument (C&I) checks are also carried out during this period.
- 5.8.15 Hot commissioning takes place once gas is available to the site and involves operating the facility with fuel and verifying that the technology functions correctly. There will be a campaign of performance & grid compliance testing at the end of this period, verifying that the facility meets its contractual performance guarantees. If there is delay in the gas transmission pipe construction the plant may be wholly or partly commissioned on secondary fuel.
- 5.8.16 Once tests are complete and the certificates are issued, the facility will be deemed ready for commercial operation.

*Maintenance*

5.8.17 Routine maintenance will be undertaken by the plant operators and contractors in accordance with maintenance manuals provided by the EPC Contractor.

5.8.18 The GT's will be subject to maintenance in accordance with the gas turbine manufacturers recommendations. The maintenance regime is generally based on annual, minor and major maintenance outages. The minor and major maintenance outage scheduling is based on the number of operating hours and starts the GT has undergone. Minor and Major outages replace annual outage in the year they take place. The outage periods may take between three days (Annual) and 17 days (Major) for the GT unit. These works are likely to take place during the summer months when the units are least likely to be operated. During this maintenance period, maintenance on balance of plant will also be undertaken.

*Operational traffic movements.*

5.8.19 Operational traffic movements are detailed within the EIAR Chapter 14: Traffic.

Electricity Grid Connection – Operational Phase

5.8.20 The Electricity Grid Connection will be managed by the respective transmission asset operators (TAO) and transmission service operators (TSO) (ESBNI and EirGrid for electricity) as part of the national grid electricity.

*Commissioning Stage*

5.8.21 Commissioning of the Electricity Grid Connection will be carried out by the EPC Contractor. During commissioning the Electricity Grid Connection will be operated in line with the EPC Contractors commissioning procedures. The EPC Contractor will implement and maintain an Environment Management System (EMS) which will be certified to International Standards Organisation (ISO) 14001. The EMS will establish the requirements and procedures required to ensure that the Site is operating to the appropriate standard.

5.8.22 Commissioning takes place in stages. Equipment will be commissioned utilising temporary and permanent power supplies. The initial period of commissioning is where equipment is initially energised and tested. Cable continuity checks and control and instrument (C&I) checks are also carried out during this period. Final commissioning will take place following the connection to the EirGrid 400kV system. Once the commissioning has been successfully completed the grid connection will undergo completion tests.

*Operational traffic movements.*

5.8.23 Operational traffic movements are detailed within the EIAR Chapter 14: Traffic.

Gas Connection Corridor – Operational Phase

5.8.24 The gas connection will be managed by GNI as part of the national gas networks.

*Commissioning and testing*

5.8.25 Commissioning and testing of the pipeline will be carried out in line with the requirements of GNI by their appointed contractor.

*Maintenance and Operation*

5.8.26 After the gas pipeline has been commissioned it will be operated and maintained by GNI in accordance with its established procedures to ensure its integrity and safe operation.

*Operational traffic movements*

5.8.27 Operational traffic movements are detailed within the EIAR Chapter 14: Traffic.



## 5.9 Proposed Decommissioning Phase

### Power Plant Area – Decommissioning Phase

- 5.9.1 It is envisaged that the Power Plant Area will have a design life of at least 25 years. At the end of the design life, the Power Plant Area would either be decommissioned, or the lifetime could potentially be extended. Decommissioning or extension of the lifetime of the asset would therefore be expected to commence at some point after 2052.
- 5.9.2 At the end of its operating life, all above-ground equipment associated with the Power Plant Area will be decommissioned and removed from the site. Prior to removing the plant and equipment, all residues and operating chemicals will be cleaned out from the plant and disposed of at a suitably licenced facility.
- 5.9.3 The bulk of the plant and equipment will have some limited residual value as scrap or recyclable materials and will be recycled at the time.
- 5.9.4 Prevention of contamination is a specific requirement of the IE Licence for the operation of the Power Plant Area and therefore the development has been designed such that it will not create any new areas of ground contamination or pathways to receptors as a result of construction or operation. Once the plant and equipment have been removed to ground level the hardstanding and sealed concrete areas will be left in place.
- 5.9.5 A Decommissioning Plan (including a Decommissioning Environmental Management Plan) will be produced and agreed with the EPA as part of the permit surrender process ahead of any permit surrender. A Decommissioning Environmental Management Plan will consider in detail all potential environmental risks on the site and contain guidance on how risks can be removed or mitigated. Site closure planning and liability risk assessment will be within the IE licence for the site and will typically include a requirement for any removal of soils, buildings, plant and equipment, and remedial actions would be undertaken under a Decommissioning Management Plan, part of a Closure, Restoration and Management Plan (CRAMP). Typically, the EPA insists on a financial bond to underwrite the CRAMP and usually with an EPA bond template. Separately under the IE licence, the applicant will likely have to prepare an Environmental Liabilities Risk Assessment which will require financial provision with the EPA to cover any liabilities of past and present activities. The ELRA is typically underwritten with an Impairment Environmental Insurance policy.
- 5.9.6 During decommissioning and demolition there will be a requirement for office, accommodation and welfare facilities which will be located adjacent to the Power Plant Area. Decommissioning activities will be conducted in accordance with the appropriate guidance and legislation at the time of decommissioning.
- 5.9.7 The Decommissioning Plan will include a programme of works.

### Electricity Grid Connection – Decommissioning Phase

- 5.9.8 The Electricity Grid Connection will be managed by the transmission asset operators (TAO) and transmission service operators (TSO) (ESBNI and EirGrid for electricity) as part of the national grid electricity. When the Electricity Grid Connection will be decommissioned depends on the asset owner's operational requirement and asset management policy.
- 5.9.9 Decommissioning activities will be conducted in accordance with the appropriate guidance and legislation at the time of decommissioning.

Gas Connection Corridor – Decommissioning Phase

- 5.9.10 The gas connection will be managed by the transmission asset operators (TAO) and transmission service operators (TSO) (GNI for gas) as part of the national gas networks. When the gas pipeline will be decommissioned depends on the asset owner's operational requirement and asset management policy.
- 5.9.11 Decommissioning activities will be conducted in accordance with the appropriate guidance and legislation at the time of decommissioning.

## 5.10 Hours of Operation

### Construction & Commissioning Phase

- 5.10.1 Details of the construction phase are provided in Section 0 of this EIAR chapter. The construction of the Power Plant Area, Electricity Grid Connection and Gas Connection Corridor will be managed by separate contractors.
- 5.10.2 The commencement of works where the removal of vegetation is required, or where works take place in sensitive breeding habitats (such as birch scrub and emergent wetland vegetation), will be scheduled to occur outside the bird breeding season (1st of March to 31st of August) to avoid any potentially significant effects on nesting birds. Construction may commence from September to March so that construction activities are ongoing by the time the next bird breeding season comes around and can continue throughout that bird breeding season.
- 5.10.3 Construction activities will be carried out during normal daytime working hours (i.e., weekdays 0700 – 1900hrs and Saturdays 0700 – 1300hrs). Specific internal erection activities may require to be undertaken on a 24 hr 7 day per week basis. To ensure that optimal use is made of good weather period or at critical periods within the programme (i.e., concrete pours) or to accommodate delivery of large turbine component along public routes it could be necessary on occasion to work outside of these hours. Any such out of hours working will be agreed in advance with the Local Authorities.

#### *Power Plant Area*

- 5.10.4 Commissioning activities will initially be carried out during normal daytime working hours (i.e., weekdays 0700 – 1900hrs and Saturdays 0700 – 1300hrs). As commissioning progresses activities will extend to 24 hours, 7 days per week.

#### *Electricity Grid Connection*

- 5.10.5 Commissioning activities will normally be carried out during normal daytime working hours (i.e., weekdays 0700 – 1900hrs and Saturdays 0700 – 1300hrs). Activities outside of these working hours will be agreed in advance with the Local Authorities.

#### *Gas Connection Corridor*

- 5.10.6 Commissioning activities will normally be carried out during normal daytime working hours (i.e., weekdays 0700 – 1900hrs and Saturdays 0700 – 1300hrs). Activities outside of these working hours will be agreed in advance with the Local Authorities

### Operational Phase

#### *Power Plant Area*

- 5.10.7 Non outage routine and non-routine maintenance operations will take place as and when required. Routine maintenance operations will be scheduled to take place during the daytime hours and will only extend into the night-time and/ or weekends should this prove necessary to maintain the continuity of the process. Any non-routine maintenance and repair operations will be undertaken as and when they arise.
- 5.10.8 The Power Plant Area will be manned and operational 24 hours, 7 days per week outside of outages. The Power Plant Area will generate power on a commercial basis. The OCGT gas fired generation will be required to potentially come into operation at any time of the day or night. The CCGT Plant will generally be run in accordance with a planned schedule in agreement with the power system operator to provide active power, grid services and maintaining system inertia to facilitate the growing installed levels of intermittent renewable generation and the forecast increase in energy demand.

*Electricity Grid Connection*

- 5.10.9 The Electricity Grid Connection will be managed and operated by the TSO and TAO and be operational 24 hours, 7 days per week.

*Gas Connection Corridor*

- 5.10.10 The gas connections will be managed by the transmission asset operators (TAO) and transmission service operators (TSO) (GNI for gas) as part of the national gas networks and be operational 24 hours, 7 days per week.

Decommissioning Phase

*Power Plant Area*

- 5.10.11 Decommissioning working hours would be generally similar to those of the construction stage.
- 5.10.12 Full details of the decommissioning stage will be presented in a Decommissioning Plan (including a Decommissioning Environmental Management Plan) to be produced and agreed with the planning authority as part of the future IE Licence and site surrender process.

*Electricity Grid Connection*

- 5.10.13 The Electricity Grid Connection will be managed and operated by the TSO and TAO. Decommissioning working hours would be generally similar to those of the construction stage.

*Gas Connection Corridor*

- 5.10.14 The gas connections will be managed by the transmission asset operators (TAO) and transmission service operators (TSO) (GNI for gas) as part of the national gas networks. Decommissioning working hours would be generally similar to those of the construction stage.

## 5.11 Staffing

### Power Plant Area – Staffing

#### *Construction Phase*

- 5.11.1 Levels of employment will vary throughout the construction phase, with peak levels of employment likely to be 400 staff average with a maximum of approximately 750 staff. Staff will comprise engineering, management, skilled and semi-skilled workers during the construction programme. A number of indirect employment opportunities would also be created in a variety of different trades as a result of the construction phases of the development.
- 5.11.2 Local businesses may benefit from the opportunity to supply materials and plant and equipment during the construction phase which will represent a significant capital investment.

#### *Operational Phase*

- 5.11.3 During the operational phase, the Power Plant Area will be operated, maintained, and managed by suitably qualified and trained personnel. There will be a high degree of automation in the Power Plant Area with all processes controlled from a shared central control room. The facility will be permanently manned 24 hours a day and seven days a week. The operations team typically comprising of two operators, and a shift team leader will work rotational shift patterns to ensure cover is provided whilst the plant is operating.
- 5.11.4 Depending on the final shift patterns this may involve 4 or 5 operations teams. The operators will be supported by a station management team, a maintenance team and administrative support staff who will work typical office hours. The management team will typically comprise the general manager, production manager and maintenance manager. The maintenance manager will manage small teams of electrical, mechanical and instrument engineers to provide routine operational maintenance support to the station and develop plans for future outages. A health, safety and environment manager will coordinate operational safety and environmental compliance. A small administrative team will deal with personnel, procurement, security and other site contracts.
- 5.11.5 It is expected that the total number of personnel employed at the Power Plant Area in the operation phase will be in the range of 40-60.
- 5.11.6 A number of indirect employment opportunities would also be created in a variety of different trades and business as a result of the operational phases of the Power Plant Area.

### Electricity Grid Connection – Staffing

#### *Construction Phase*

- 5.11.7 There will be a peak of 120 staff numbers in construction across the Electricity Grid Connection.

#### *Operational Phase*

- 5.11.8 The Electricity Grid Connection will be managed by the transmission asset operators (TAO) and transmission service operators (TSO) (ESBNI and EirGrid).
- 5.11.9 It is not proposed that the Electricity Grid Connection or substations will be manned although periodic inspections and maintenance activities will be undertaken intermittently.

Gas Connection Corridor – Staffing

*Construction Phase*

- 5.11.10 Staff numbers will be dependent on how many work crews the contractor employs however it is expected that these will peak at 120.

*Operational Phase*

- 5.11.11 The gas connections will be managed by the transmission asset operators (TAO) and transmission service operators (TSO) (GNI for gas); as part of the national gas networks.
- 5.11.12 Telemetry via satellite will be used to interface with the TAO/TSO control room and the AGI's to reduce the need for manned inspection. It is not proposed that the AGIs will be manned although periodic inspections and maintenance activities will be undertaken intermittently.



## **5.12 Community Benefit Proposal**

- 5.12.1 A Community Benefit Fund will be set up for the Proposed Development. The fund shall be made by five annual payments of €90,000 (ninety thousand euro), beginning on commencement of construction of the Proposed Development contributing to a total fund of €450,000 (four hundred and fifty thousand euro) over the five-year period. As the project is at an early stage of its development, the exact nature and structure of the proposed Community Benefit Fund, including details of the management and operation of the Fund, is not known at this time. It is envisaged that the Community Benefit Fund will operate in a similar manner to other Bord na Móna Community Benefit Fund models currently in operation.

### 5.13 References

Construction Industry Research and Information Association (April 2016) Environmental good practice on site pocketbook. Technical guidance (C762).

Construction Industry Research and Information Association (January 2015) Environmental good practice on site guide (C741).

Construction Industry Research and Information Association (January 2001) Control of water pollution from construction sites: guidance for consultants and contractors (C532D).

Construction Industry Research and Information Association (May 2006) Control of Water Pollution from Linear Construction Projects Technical Guidance (C648D).

Environment Agency, Northern Ireland Environment Agency and Scottish Environment Protection Agency (2012) PPG 6: Working at construction and demolition sites.

Environmental Protection Agency (April 2021) Best Practice Guidelines for The Preparation of Resource Management Plans for Construction & Demolition Projects.

Natural Resources Wales, Northern Ireland Environment Agency and Scottish Environment Protection Agency (October 2020) GPP 1: Understanding your environmental responsibilities - good environmental practices.

Natural Resources Wales, Northern Ireland Environment Agency and Scottish Environment Protection Agency (January 2018) GPP 2: Above ground oil storage tanks.

Natural Resources Wales, Northern Ireland Environment Agency and Scottish Environment Protection Agency (February 2018) GPP 5: Works and maintenance in or near water.

Natural Resources Wales, Northern Ireland Environment Agency and Scottish Environment Protection Agency (2017) GPP 8: Safe storage and disposal of used oils.

Natural Resources Wales, Northern Ireland Environment Agency and Scottish Environment Protection Agency (June 2021) GPP 21: Pollution incident response planning.

Natural Resources Wales, Northern Ireland Environment Agency and Scottish Environment Protection Agency (October 2018) GPP 22: Dealing with spills.



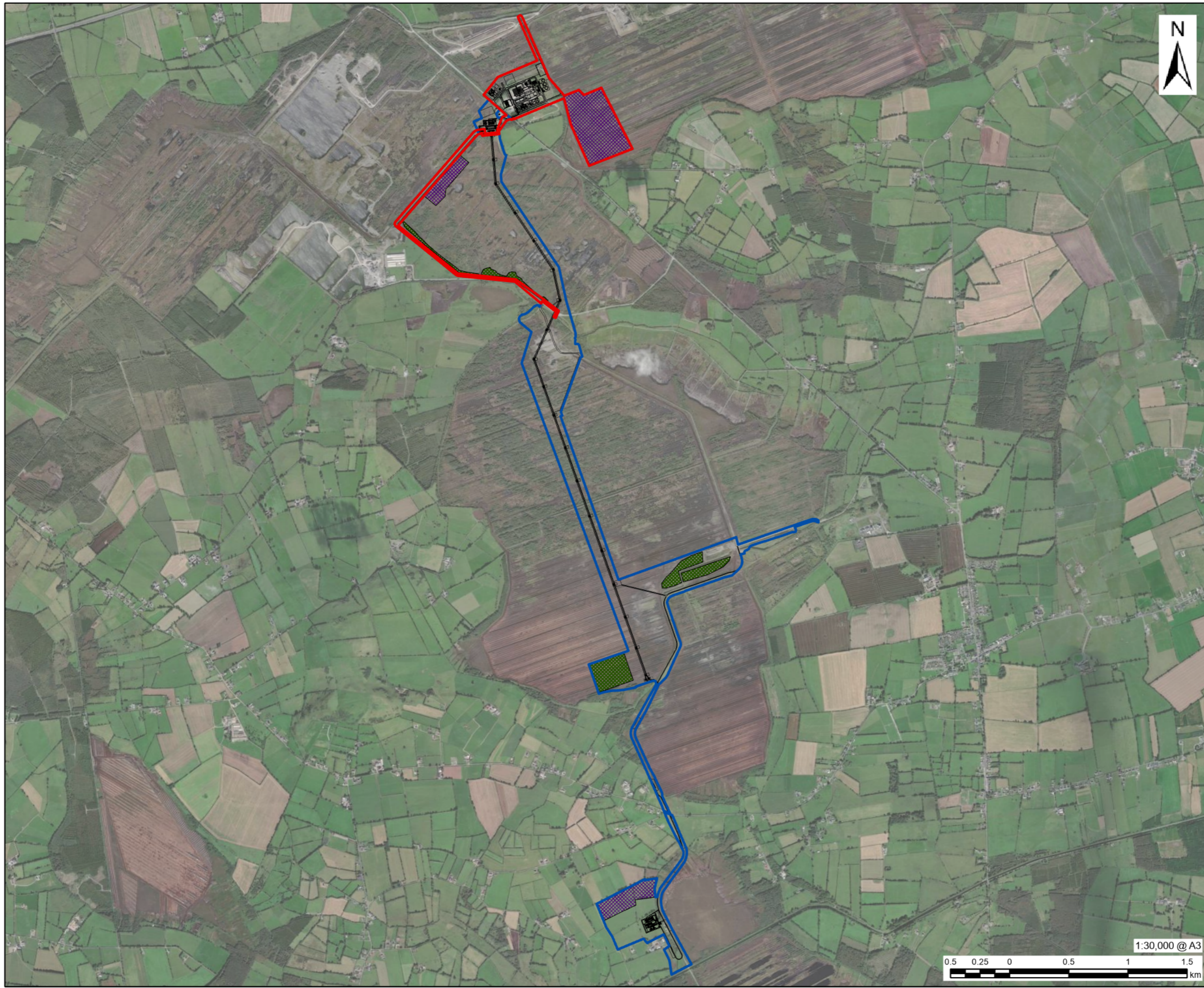

- Power Plant Area Boundary
- Electricity Grid Connection Boundary
- Project Elements**
- Project Layout
- Tree Replanting Area
- Peat Deposition Area

**NOTES**

Copyright Government of Ireland. Licenced for re-use under the Creative Commons attribution 4.0 International Licence.  
Maxar, Microsoft, Esri UK, Esri, TomTom, Garmin, FAO, NOAA, USGS

**ISSUE PURPOSE**

FOR ISSUE

**PROJECT NUMBER**

60699676

**FIGURE TITLE**

Proposed Development and Overall Project Layout

**FIGURE NUMBER**

Figure 5.1

1:30,000 @ A3

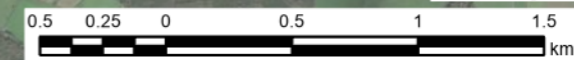

This drawing has been prepared for the use of AECOM's client. It may not be used, modified, reproduced or relied upon by third parties, except as agreed by AECOM, and denies any liability whatsoever, to any party that uses or relies on this drawing without AECOM's express written consent. Do not scale this document. All measurements must be obtained from the stated dimensions.



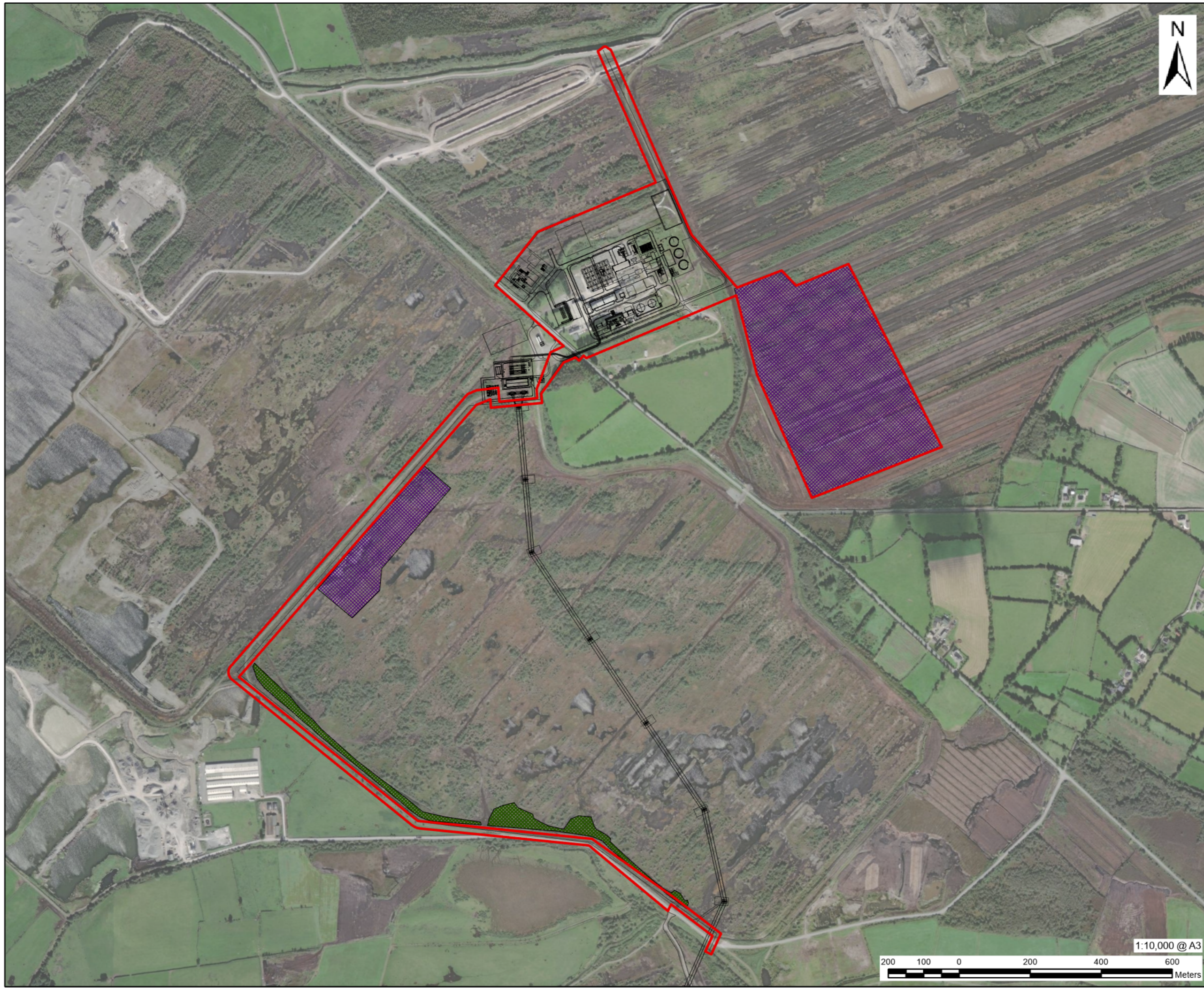

- Power Plant Area Boundary
- Project Elements*
- Project Layout
- Tree Replanting Area
- Peat Deposition Area

**NOTES**

Copyright Government of Ireland. Licenced for re-use under the Creative Commons attribution 4.0 International Licence.  
Maxar, Microsoft, Esri UK, Esri, TomTom, Garmin, FAO, NOAA, USGS

**ISSUE PURPOSE**

FOR ISSUE

**PROJECT NUMBER**

60699676

**FIGURE TITLE**

Power Plant Area – Proposed Layout

**FIGURE NUMBER**

Figure 5.2



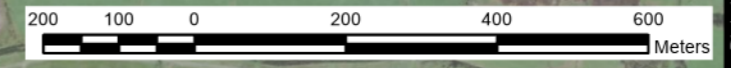

1:10,000 @ A3

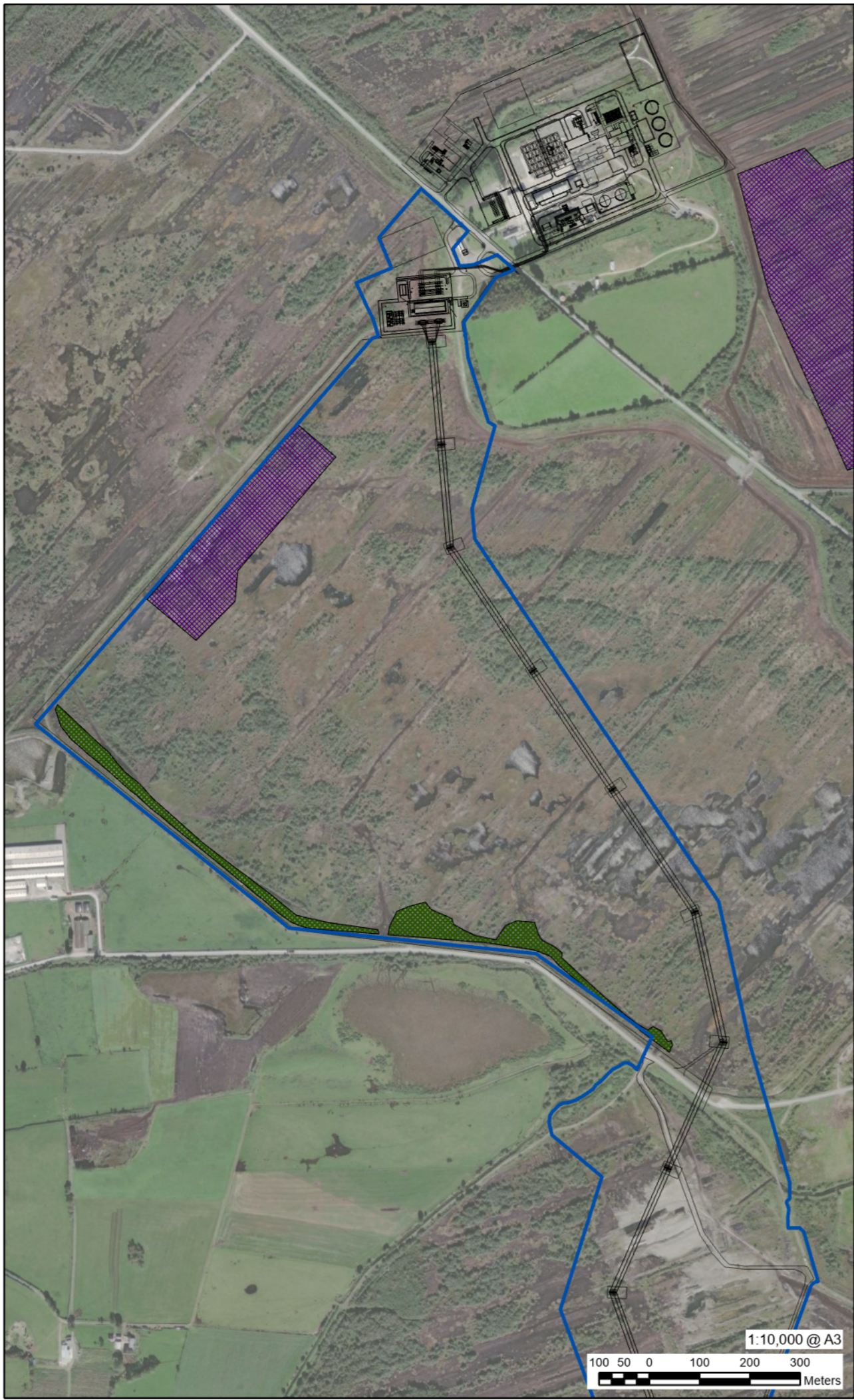

This drawing has been prepared for the use of AECOM's client. It may not be used, modified, reproduced or relied upon by third parties, except as agreed by AECOM, and denies any liability whatsoever, to any party that uses or relies on this drawing without AECOM's express written consent. Do not scale this document. All measurements must be obtained from the stated dimensions.





-  Electricity Grid Connection Boundary
- Project Elements**
-  Project Layout
-  Tree Replanting Area
-  Peat Deposition Area

**NOTES**  
Copyright Government of Ireland. Licensed for re-use under the Creative Commons attribution 4.0 International Licence.  
Maxar, Microsoft, Esri UK, Esri, TomTom, Garmin, FAO, NOAA, USGS

**ISSUE PURPOSE**  
FOR ISSUE  
**PROJECT NUMBER**  
60699676  
**FIGURE TITLE**  
Electricity Grid Connection – Proposed Layout





**FIGURE NUMBER**  
Figure 5.3a

This drawing has been prepared for the use of AECOM's client. It may not be used, modified, reproduced or relied upon by third parties, except as agreed by AECOM or as required by law. AECOM accepts no responsibility, and denies any liability whatsoever, to any party that uses or relies on this drawing without AECOM's express written consent. Do not scale this document. All measurements must be obtained from the stated dimensions.





**LEGEND**

	Electricity Grid Connection Boundary
<i>Project Elements</i>	
	Project Layout
	Tree Replanting Area
	Peat Deposition Area

**NOTES**  
Copyright Government of Ireland. Licenced for re-use under the Creative Commons attribution 4.0 International Licence.  
Maxar, Microsoft, Esri UK, Esri, TomTom, Garmin, FAO, NOAA, USGS

**ISSUE PURPOSE**  
FOR ISSUE  
**PROJECT NUMBER**  
60699676  
**FIGURE TITLE**  
Electricity Grid Connection – Proposed Layout

**FIGURE NUMBER**  
Figure 5.3b

This drawing has been prepared for the use of AECOM's client. It may not be used, modified, reproduced or relied upon by third parties, except as agreed by AECOM or as required by law. AECOM accepts no responsibility, and denies any liability whatsoever, to any party that uses or relies on this drawing without AECOM's express written consent. Do not scale this document. All measurements must be obtained from the stated dimensions.